

SMITHS RADIO & TV  
850 LAURELWOOD ROAD  
POTTSTOWN, PA 19464

March, 1976 □ 75 cents

# Electronic Servicing



A HOWARD W. SAMS PUBLICATION

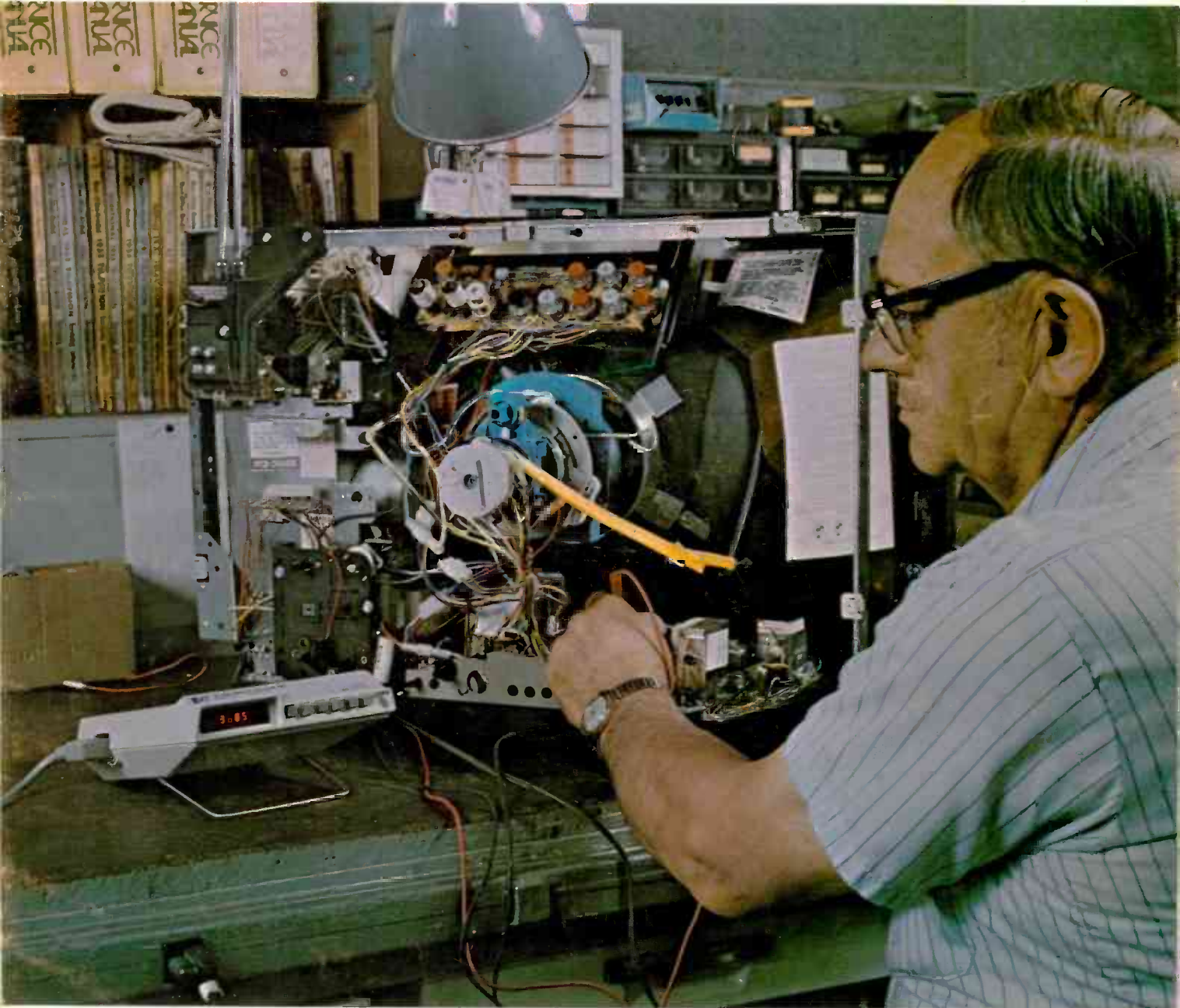

**COLOR CASEBOOK**

**Audio Quiz**

**XL-100 SCR Sweep**

**Test Lab**

# You've Got Us Where You Want Us

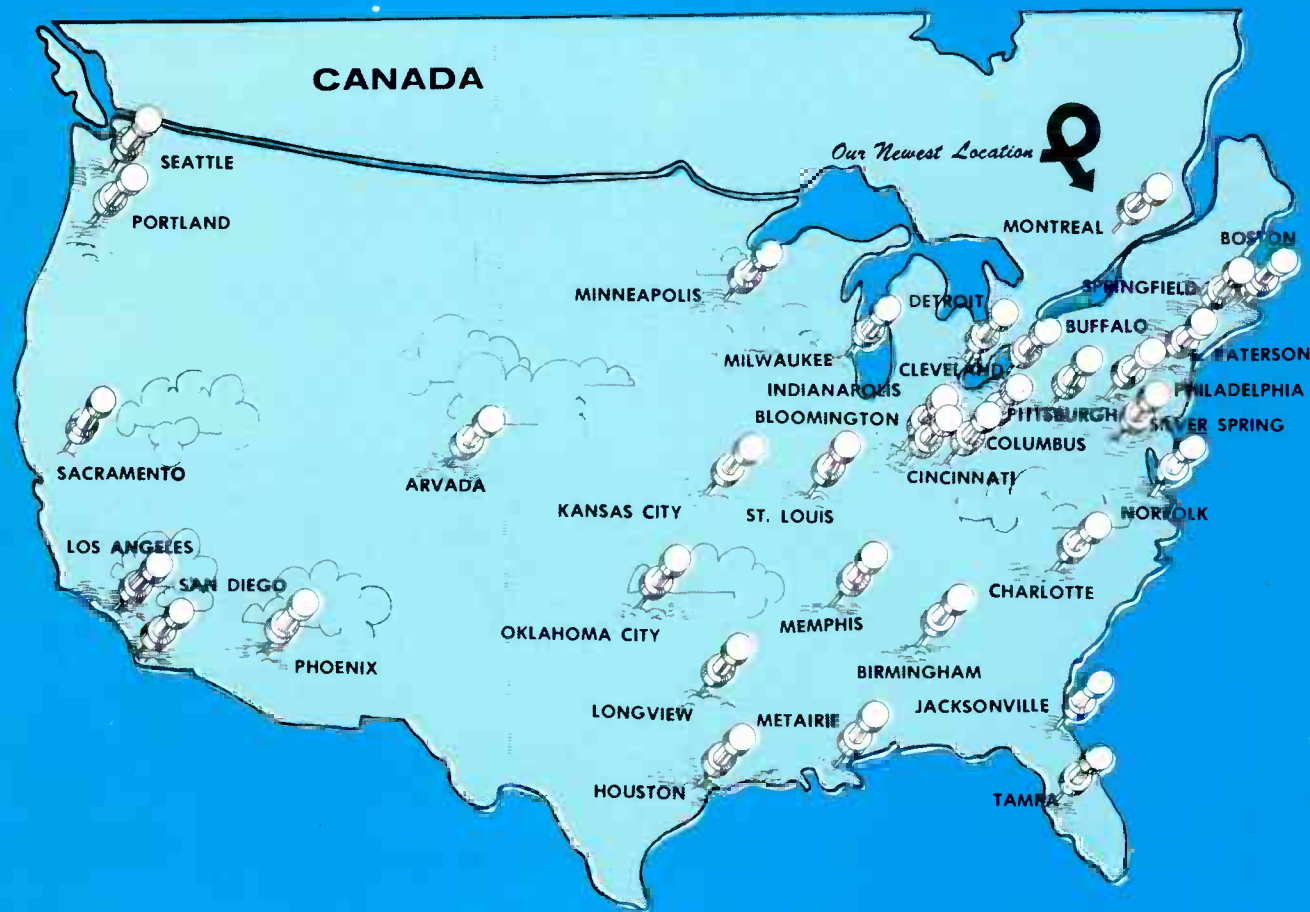

Even though we're the world's largest tuner repair service, recommended by more TV manufacturers than any other company, we think small. Really! We could put the whole thing under one roof. Instead, we have 35 small service centers across the country, staffed by more than 200 professional technicians. Why? Service for one thing . . . same-day

service. Bring us a tuner . . . any tuner . . . at 8 a.m. and it's repaired and tested by 4 p.m. Then there's quality . . . original parts, and once repaired, it's good as new. Oh sure, being the world's largest is something we're proud of. But we also like the fact that with 35 service locations, we can be small enough to give every tuner repair job a personal as well as a professional touch.



## ELECTRONICS, INC.

PRECISION TUNER SERVICE

Consult the white pages of your telephone directory for the address and telephone number of the PTS center nearest you.

For More Details Circle (1) on Reply Card





B&K-PRECISION  
Model 520B Transistor Tester  
**\$160.00**

NOW WITH  
HI/LO DRIVE

**ACCURATE  
TESTING  
IN OR OUT  
OF CIRCUIT**

- All bipolar transistors, including hard-to-check Darlington's.
- FET's, SCR's, Diodes

# In-circuit semiconductor testing and lead identification — automatically

**New!** The HI/LO power drive circuitry of the B&K-PRECISION Model 520B provides two important benefits.

You now can test accurately even more transistors and semiconductors in-circuit—and with shunt resistances as low as 10 ohms and shunt capacitances up to 15  $\mu$ F. You won't waste time resoldering leads because of faulty in-circuit testing.

Second, in LO drive you get positive, automatic identification of all three transistor leads.

The new Model 520B transistor tester is fast, too. A complete test can take less than nine seconds! With the tester in LO drive, just connect any test clip to any lead of the device to be tested. Move the test switch through its six positions until you hear a pulsating audio tone, which indicates a good semiconductor, plus lead identification. If you don't get a tone, switch to HI drive and operate the switch again. Now a tone indicates a good semiconductor and identifies the base.

With the Dynapeak™ transistor testing method, you can be confident of a valid in-circuit and out-of-circuit test. A window indicates the leads to

which each probe is connected. Two LED's automatically tell you whether the device is PNP or NPN.

Out-of-circuit tests are equally easy and fast with the convenient mini-lock probes or the plug-in test socket. Leakage tests can be made without referring to charts. The meter panel is marked for both germanium and silicon devices, which are automatically identified by LED indicator lamps.

Ask for a demonstration of the 520B at your local distributor. Or write for our full color brochure explaining how the B&K-PRECISION Model 520B Transistor Tester will end time-wasting diagnostic errors and speed your solid state testing and service.

**BK PRECISION**  
PRODUCTS OF DYNASCAN

1801 West Belle Plaine Avenue  
Chicago, Illinois 60613 312/525-3990  
In Canada: Atlas Electronics, Toronto

For More Details Circle (4) on Reply Card

# Electronic Servicing

## *in this issue...*

- 15 **Man's Best Friend...His TV!**—A new shop owner discovers the fanatical devotion of a viewer for his TV receiver—*Terry L. Turner.*
- 18 **Color Casebook**—Pages from an expert's record of the best methods used to repair various defects—*Robert L. Goodman. CET.*
- 23 **Servicing Stereo Audio Systems, Part 7**—Take this review quiz covering the first six parts of the basic audio series—*Carl Babcoke. CET.*
- 25 **Medical Electronics Notebook, Part 3**—Here is another helpful listing of medical-electronic equipment, how to pronounce the names, and what each device does—*Ed Bukstein.*
- 28 **Reports From The Test Lab**—Features and performance of the Hewlett-Packard Model 3476A digital multimeter; the first autoranging, autopolarity meter we have examined—*Carl Babcoke.*
- 32 **Servicing RCA XL-100, Part 5**—HV-regulation and pincushion circuits are analyzed and distinctive waveforms caused by parts defects are shown—*Gill Grieshaber. CET.*
- 41 **Ohmward Bound!**—Relax while you work this pinwheel puzzle that's based on electronics—*Edmund A. Braun.*

### ABOUT THE COVER

Marvin Jungemeyer of Bob Hipps TV in Loveland, Colorado is shown using a Hewlett-Packard Model 3476A digital multimeter to test a color TV. Photo courtesy of Hewlett-Packard.

### DEPARTMENTS

Electronic Scanner .....	4
Symcure .....	8
Troubleshooting Tips .....	10
Reader's Exchange .....	11
Product Report .....	45
Test Equipment .....	42
Book Review .....	49
Photofact .....	49
Catalogs and Literature .....	52
Advertiser's Index .....	54

Second class postage paid at Shawnee Mission, Kansas and additional mailing offices. Published monthly at 9221 Quivira Road, Shawnee Mission, Kansas 66215 by Intertec Publishing Corp., 1014 Wyandotte St., Kansas City, Mo 64105. Send Form 3579 to 9221 Quivira Road, Shawnee Mission, Ks. 66215.

© Copyright, 1976, Howard W. Sams & Co., Inc. All rights reserved. Material may not be reproduced or photocopied in any form without written permission of publisher.

**EDITORIAL**  
RONALD N. MERRELL, Director  
CARL H. BABCOKE, Managing Editor  
SHARON ELWOOD, Editorial Assistant  
DUDLEY ROSE, Graphic Designer

**ELECTRONIC SERVICING**  
1014 Wyandotte Street  
Kansas City, Missouri 64105

**TECHNICAL CONSULTANT**  
JOE A. GROVES

**EDITORIAL ADVISORY BOARD**  
LES NELSON, Chairman  
Howard W. Sams & Co., Indianapolis

**CIRCULATION**  
EVELYN ROGERS, Manager

**ADVERTISING SALES**  
Kansas City, Missouri 64105  
Tele: 913/888-4664  
**MIKE KREITER**, Director  
**JOHN COX**  
GLORIA PARMENTER, Production

**REGIONAL ADVERTISING SALES OFFICES**  
Indianapolis, Indiana 46280  
**ROY HENRY**  
2469 E. 98th St.  
Tele: 317/846-7026

Greenlawn, New York 11740  
**CHARLES C. HORNER**  
P.O. Box 175  
Tele: (516) 757-8868

Mountain View, California 94043  
**DENNIS TRIOLA**  
2680 Bayshore Frontage Road, Room 102  
Tele: 415/961-0378

London W. C. 2, England  
**JOHN ASHCRAFT & CO.**  
12 Bear Street  
Leicester Square  
Tele: 930-0525

Badhoevedorp, Holland  
John Ashcraft & Co.,  
John J. Lucassen, Mgr.  
Sloterweg 303

Tokyo, Japan  
**INTERNATIONAL MEDIA REPRESENTATIVES LTD.**  
1, Shiba-Kotohiracho, Minatoku  
Tele: 502-0656



**ELECTRONIC SERVICING** (with which is combined PF Reporter) is published monthly by Intertec Publishing Corp., 1014 Wyandotte Street, Kansas City, Missouri 64105.

**Subscription Prices:** 1 year — \$6.00, 2 years — \$10.00, 3 years — \$13.00, in the U.S.A. and its possessions.

All other foreign countries: 1 year — \$7.00, 2 years — \$12.00, 3 years — \$16.00. Single copy 75c; back copies \$1. Adjustment necessitated by subscription termination to single copy rate.

 **Robert E. Hertel**, Publisher  
**INTERTEC PUBLISHING CORP.**  
Subsidiary of HOWARD W. SAMS & CO., INC.



# Buss® Fuses Specialize Too!

*in the protection of*

# CB

## EQUIPMENT

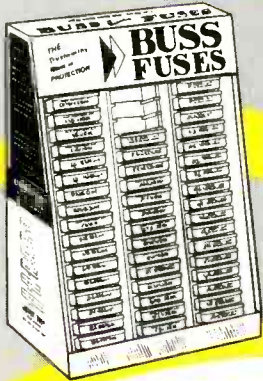

No. 240CB-3  
Metal Display Stand

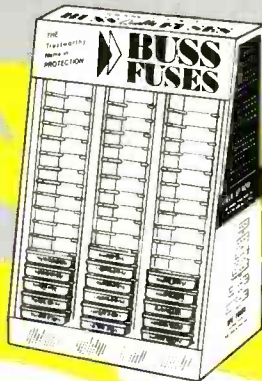

No. 80CB-1  
Metal Display Stand

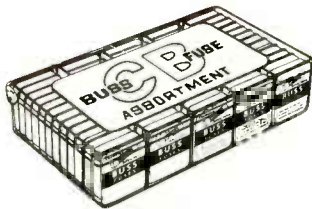

No. 240CB-4  
Plastic Display Box

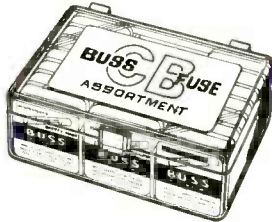

No. 80CB-2  
Plastic Display Box

Now . . . four new BUSS fuse assortments exclusively designed with replacement fuses to service most Citizen Band Radios — offering a whole new area of opportunities for increased profits.

Two assortments contain 48 — 5 in metal boxes (240 fuses). BUSS No. 240CB-3 fuse assortment comes in a handy metal display stand. BUSS No. 240CB-4 fuse assortment is packed in a compact plastic display box.

In addition, there are two fuse assortments containing 16 — 5 in metal boxes (80 fuses). BUSS No. 80CB-1 fuse assortment packed in a metal display stand and BUSS No. 80CB-2 fuse assortment in a plastic display box.

Both BUSS fuse assortments contain a careful selection of the most popular fuses used in CB radios.

CB dealers can now have the fuses they need in a neat complete package to service all their customers fuse needs.

For full fuse assortment details, write for BUSS Bulletin CBA.



BUSSMANN MANUFACTURING  
a McGraw-Edison Company Division  
St. Louis, Missouri 63107



# electronic scanner

news of the industry

---

**Newest idea of auto electronics is the combination of CB and FM-stereo functions in one radio.** Panasonic Auto Products now offers an in-dash radio having AM/FM-stereo with pushbuttons, and 23-channel CB. In addition to the usual CB features of metered power and sensitivity, variable squelch control, and Delta tuning, there is a standby monitor that permits the reception of CB calls while the radio is tuned to AM or FM broadcasts. Four-way adjustable control shafts are said to allow installation in the dash of most cars. The first company to market a stereo/CB combination was J.I.L. Corporation, which last summer introduced a CB/AM/FM/8-track stereo unit. Other manufacturers appear to be waiting for public acceptance before marketing similar combinations.

**Retail sales authorities predict sales increases** during 1976 for projection TV, home-security systems, telephone-answering devices, CB equipment, scanner radios, and microwave ovens.

**B&K Dynascan reports a 32% increase** of test equipment sales, and a 400% sales increase of CB radio equipment for 1975 compared to 1974.

**Litton has expanded the warranty on its microwave ovens** and reduced the price of the magnetron tube. The 600-watt magnetron tubes (produced in Japan) formerly listed at \$129, and now are offered for \$78 retail. Both parts and labor are covered for one year, and the magnetron is warranted for 4 additional years without labor. Total industry sales of microwave ovens are expected to exceed 3 million units by 1980.

**RCA Corporation has announced the closing of its receiving-tube plant** in Harrison, New Jersey by July 30th of this year. Approximately 1,100 employees will be affected by the closing, and RCA will help them relocate. Peak production was 87 million tubes a year, but since 1966 industry sales of receiving tubes have declined by almost 80%, with most of the present production going into older equipment, according to RCA. However, RCA intends to continue selling receiving tubes.

**Toshiba is the sixth Japanese company** to sign a licensing agreement to acquire RCA technology on the video-disc player. According to **Home Furnishings Daily**, the other companies that have received the RCA license are Sharp, Pioneer Electronic, General, New Nippon Electric, and Clarion. RCA said it will be ready to produce video-disc players by the end of this year.

**A 47% increase of first-quarter sales of test instruments** over the same quarter of last year was reported by Sencore, Inc., according to **Radio & Television Weekly**.

**New figures submitted to the National Electronic Service Dealers Association (NESDA)** by ten major state or city licensing boards around the country show a 6.5% increase in the number of electronic technicians, or an additional 12,781 workers of the 196,347 total. Contrasting that figure is the total of service businesses which declined by 6,165. Dick Glass, Executive Vice President of NESDA, attributes the 6.5% increase in technicians nationwide to the recession.

(Continued on page 6)

---



# TUNER SERVICE CORPORATION

**SUBSTITUNER**



JUST

**\$44.95**  
U.S.A. ONLY

WITH CABLES

ONE YEAR  
GUARANTEE

STILL ONLY

**\$9.95**  
U.S.A. ONLY



MAJOR PARTS  
AND SHIPPING  
CHARGED AT COST

## FEATURES

- A UHF Tuner with 70 channels which are detented and indicated just like VHF channels.
- A VHF Hi Gain Solid State Tuner.
- AC Powered • 90 Day Warranty

Demonstrate the **SUBSTITUNER** to your customers and show improved reception with their TV sets.

You may place your order through any of the Centers listed below.

## NEWS FLASH!

NOW AVAILABLE—TUNER SERVICE PARTS CATALOG OF ALL SARKES TARZIAN VHF AND UHF TUNERS, INCLUDING EXPLODED VIEW DRAWINGS. OVER 200 PAGES. ORDER YOUR COPY TODAY. SEND \$2.50 WITH ORDER TO BLOOMINGTON HEAD OFFICE.

PROVIDES YOU WITH A COMPLETE SERVICE FOR ALL YOUR TELEVISION TUNER REQUIREMENTS.

## REPAIR

VHF OR UHF ANY TYPE ..... (U.S.A. ONLY) \$ 9.95  
UHF/VHF COMBINATION ..... (U.S.A. ONLY) \$15.00

MAJOR PARTS AND SHIPPING  
CHARGED AT COST

- Fast, efficient service at our conveniently located Service Centers.
- All tuners are ultrasonically cleaned, repaired, realigned, and air tested.

## REPLACE

UNIVERSAL REPLACEMENT TUNER \$12.95 (U.S.A. only)

- This price buys you a complete new tuner built specifically by Sarkes Tarzian Inc. for this purpose.
- All shafts have a maximum length of 10½" which can be cut to 1½".
- Specify heater type parallel and series 450 mA. or 600 mA.

## CUSTOMIZE

- Customized tuners are available at a cost of only \$15.95. With trade-in \$13.95. (U.S.A. only)
- Send in your original tuner for comparison purposes to any of the Centers listed below.



WATCH US  
GROW

HEADQUARTERS	BLOOMINGTON, INDIANA 47401	537 South Walnut Street	Tel. 812-334-0411
ARIZONA	TUCSON, ARIZONA 85713	1528 S. 6th Ave.	Tel. 602-791-9243
CALIFORNIA	NORTH HOLLYWOOD, CALIF. 91601	10654 Magnolia Boulevard	Tel. 213-769-2720
	BURLINGAME, CALIF. 94010	1324 Marsten Road	Tel. 415-347-5728
	MODESTO, CALIF. 95351	123 Phoenix Avenue	Tel. 209-521-8051
FLORIDA	TAMPA, FLORIDA 33606	1505 Cypress Street	Tel. 813-253-0324
	FT. LAUDERDALE, FLORIDA 33315	104 S.W. 23rd St., Bldg. 16	Tel. 305-524-0914
GEORGIA	ATLANTA, GA. 30310	646 Evans St. S.W.	Tel. 404-758-2232
ILLINOIS	CHAMPAIGN, ILLINOIS 61820	405 East University Street	Tel. 217-356-6400
	DOLTON, ILL. 60419	1507-09 E. 142nd St.	Tel. 312-841-4444
	SKOKIE, ILLINOIS 60078	5110 West Brown Street	Tel. 312-575-0230
INDIANA	INDIANAPOLIS, INDIANA 46204	112 West St. Clair Street	Tel. 317-632-3493
IOWA	DES MOINES, IOWA 50319	5005 Douglas St. #5E	Tel. 319-278-4217
KENTUCKY	LOUISVILLE, KENTUCKY 40205	2244 Taylorsville Road	Tel. 502-452-1191
LOUISIANA	SHREVEPORT, LOUISIANA 71104	3025 Highland Avenue	Tel. 318-221-3027
MARYLAND	BALTIMORE, MARYLAND 21215	5505 Reisterstown Rd., Box 2824	Tel. 301-358-1186
MASSACHUSETTS	SPRINGFIELD, MASS. 01108	405 Dickinson St.	Tel. 415-788-8206
MISSOURI	ST. LOUIS, MISSOURI 63132	10530 Page Avenue	Tel. 314-429-0633
NEVADA	LAS VEGAS, NEVADA 89102	1812 Western Avenue No. 1	Tel. 702-384-4235
NEW JERSEY	TRENTON, NEW JERSEY 08648	1139 Pennsylvania Ave.	Tel. 609-393-0999
	JERSEY CITY, NEW JERSEY 07307	547-49 Tonnele Ave., Hwy. 1 & 9	Tel. 201-792-3730
N. CAROLINA	GREENSBORO, N.C. 27405	2914 E. Market Street	Tel. 919-273-6276
OHIO	CINCINNATI, OHIO 45218	7450 Vine Street	Tel. 513-821-5080
	CLEVELAND, OHIO 44109	4525 Pearl Road	Tel. 216-741-2314
OREGON	PORTLAND, OREGON 97210	1732 N.W. 25th Ave., P.O. Box 10141	Tel. 503-222-9059
PENNSYLVANIA	PITTSBURGH, PA. 15209	503 1/2 Grant Avenue	Tel. 412-821-4004
TENNESSEE	MEMPHIS, TENNESSEE 38111	3158 Barron Avenue	Tel. 901-458-2355
TEXAS	DALLAS, TEXAS 75218	11540 Garland Road	Tel. 214-327-8413
VIRGINIA	NORFOLK, VIRGINIA 23513	3295 Santos Street	Tel. 804-855-2518
CANADA	ST. LAURENT, QUEBEC H4N-2L7	305 Decarie Boulevard	Tel. 514-748-8803
	CALGARY, ALBERTA T2H-0L1	448 42nd Avenue S.E.	Tel. 403-243-0971
		P.O. Box 5823, Stn. "A"	

IF YOU WANT TO BRANCH OUT INTO THE TV TUNER REPAIR BUSINESS, WRITE TO THE BLOOMINGTON HEADQUARTERS ABOUT A FRANCHISE.

For More Details Circle (5) on Reply Card

[www.americanradiohistory.com](http://www.americanradiohistory.com)

(Continued from page 4)

A **technical seminar for 61 installers and users** of the Blonder-Tongue line of MATV and CATV equipment was conducted recently in Atlanta, Georgia by Dwight Staehler and Marc Winchester. The two-full-day seminar covered equipment selection, system design, and maintenance and troubleshooting. A practical hands-on workshop also was included.

**RCA plans to sell its electronic-instrument business** to Viz Manufacturing Company of Philadelphia. The contract is subject to approval by the boards of both companies. RCA Distributor and Special Products Division decided to restructure its operations to emphasize other product lines. Viz plans to take over distribution of the present inventory of RCA instruments and to continue manufacture of these type instruments, augmented by an expanded line of high-quality instruments under its own trade name. Viz has been a supplier to RCA of electronic instruments since 1958, and has produced many of the well-known RCA volt-ohm-milliammeters, oscilloscopes, signal generators, and a variety of probe assemblies and battery testers.

**Zenith Radio Corporation was advised by the Bureau of Radiological Health (BRH)** that Zenith color television receivers using the 22-7233 capacitor do not "create a significant risk of injury, including genetic injury to any person". The Bureau, therefore, granted Zenith an exemption from the requirements of notification and repair of these receivers. The 22-7233 capacitor was not used in Zenith color TV receivers sold before January 1, 1974; and it is not used in Zenith current-model color television receivers. Zenith is continuing to honor claims for replacing this capacitor.

**The Veteran Wireless Operators Association (VWOA)** celebrated the fiftieth year of its founding by presenting President Gerald Ford with a telegraph sounder. J. R. Poppele made the award to the chief executive. VWOA has over 360 current and former wireless operators in its membership. Guglielmo Marconi, Lee DeForest, and David Sarnoff were members.

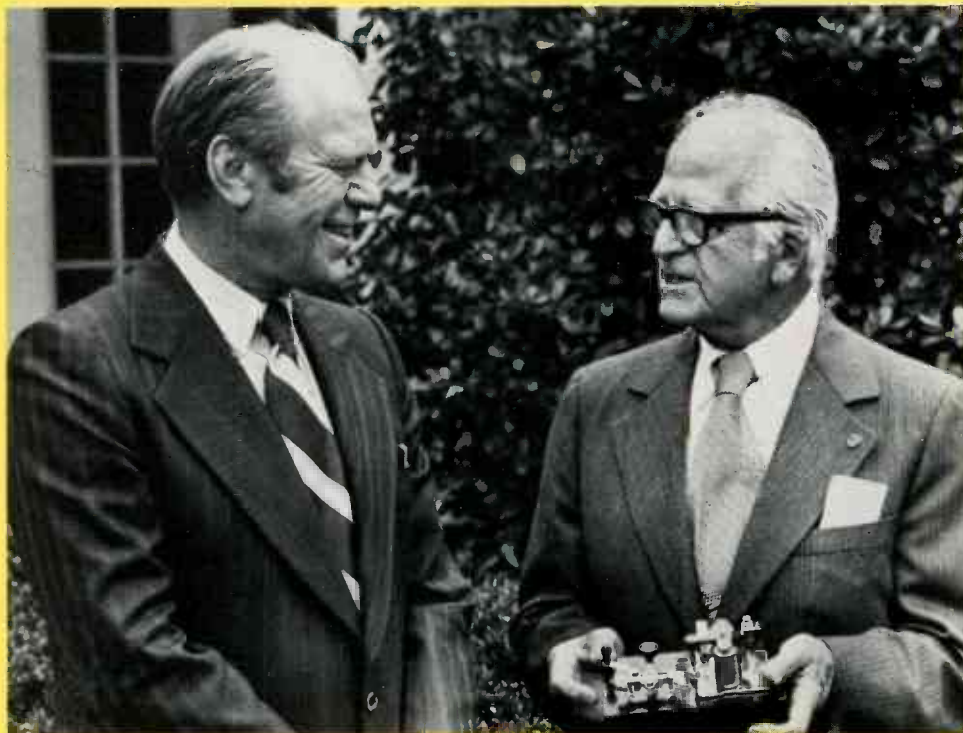



# Just off the press from Sams.

The latest guides, manuals, and licensing handbooks all designed to save the electronics technician time and money!



## Servicing Electrocadiographs

by Elliott S. Kanter

Discusses many models of ECG's, including the new portables. Filled with instructions for troubleshooting, repair, and assembly. 224 pages. NO. 21210—\$12.95

## Scanner-Monitor Servicing Guide

by Robert G. Middleton

A brand-new guide to scanner-monitor receivers and their unique circuitry. All the data you need to take advantage of servicing opportunities in this booming field. 96 pages. NO. 21306—\$4.95

## Digital Equipment Servicing Guide

by Robert G. Middleton

Helps technicians expand beyond radio and TV "linear" circuitry. Well-illustrated, step-by-step guidance on all kinds of digital equipment. 104 pages. NO. 21200—\$5.95

## Electronic Organs (Volume 3)

by Norman H. Crowhurst

Complete circuit discussions of organs produced by ten well-known manufacturers. Block diagrams and schematics of various models that include new IC and LSI circuitry. 144 pages. NO. 21176—\$7.95

## Semiconductor Replacement Guide

by Howard W. Sams Engineering Staff

"Quick-find" manual for looking up replacement parts. Lists bi-polar and field-effect transistors, diodes, rectifiers, or integrated circuits from seven manufacturers. 256 pages. NO. 21092—\$3.95

## Transistor Specifications Manual (7th Edition)

by Howard W. Sams Engineering Staff

Why search hard for electrical and physical data on a specific transistor type? Here are specs on nearly every bipolar transistor. 224 pages. NO. 21208—\$5.95

## Troubleshooting with the Oscilloscope (3rd Edition)

by Robert G. Middleton

All about troubleshooting, signal-tracing, and testing TV, radio, and audio equipment. New material on dual-trace, triggered-sweep, and triggered time-base scopes. 192 pages. NO. 21103—\$5.50

## Mobile Radio Servicing Made Easy

by Leo G. Sands

Features the latest troubleshooting, repair, and even business techniques—all training-school perfected. Covers 2-way radio meters, analyzers, counters, and generators. 144 pages. NO. 21178—\$4.95

## Frequency and its Measurement

by Rufus P. Turner

Far more facts on measuring frequency than found in most textbooks. Helps you find the right measurement methods—fast. 96 pages. NO. 21179—\$3.95



## Marine Radiotelegraph Operator License Handbook

By Edward M. Noll

New guide for passing radiotelegraph license exams. Covers rules and regulations. Hundreds of answers on amplifiers, transmitters, antennas, and more. Also includes radar endorsement to FCC license. 320 pages. NO. 21109—\$9.95

## Study Guide for Associate CET Examinations

by J. A. Wilson, R. Glass & R. Crow

A thorough review of knowledge needed to be a Certified Electronic Technician, associate level. Each section of the exam is covered by a single, easy-to-read chapter. 320 pages. NO. 20972—\$7.95

## Clip Out-Mail Today!

161

Send books checked at right. \$\_\_\_\_\_ enclosed\* I understand that, if not completely satisfied, I may return my order within 10 days for full refund.

Name \_\_\_\_\_ (please print)

Address \_\_\_\_\_

City \_\_\_\_\_

State \_\_\_\_\_ Zip \_\_\_\_\_

\*Include sales tax where applicable. Canadian prices slightly higher.

TC-15

- 21210
- 21306
- 21200
- 21176
- 21092
- 21208
- 21103
- 21178
- 21179
- 21109
- 20972



**Howard W. Sams & Co., Inc.**

4300 West 62nd Street/Indianapolis, Indiana 46206

Chassis—RCA CTC58  
PHOTOFACT—1428-2

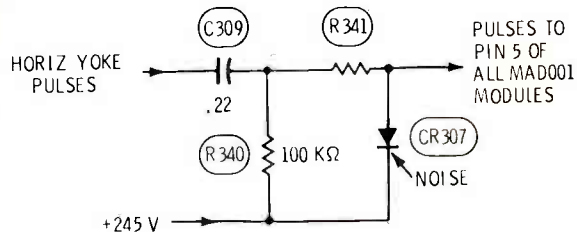

**Symptom**—Noise streaks in the video  
**Cure**—As a test, replace CR307

Chassis—RCA CTC58  
PHOTOFACT—1428-2

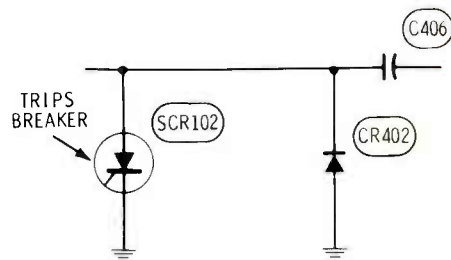

**Symptom**—Circuit breaker trips from increased brightness  
**Cure**—As a test, replace SCR102

Chassis—RCA CTC58  
PHOTOFACT—1428-2

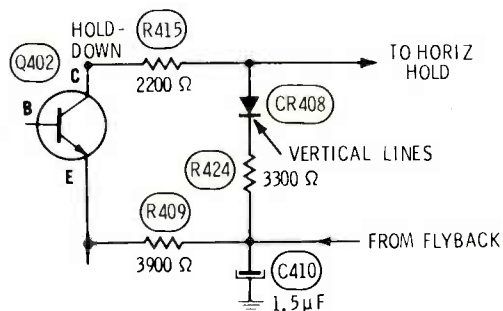

**Symptom**—Vertical lines in picture, and bending at high brightness.  
**Cure**—Replace CR408

Chassis—RCA CTC68  
PHOTOFACT—1378-2

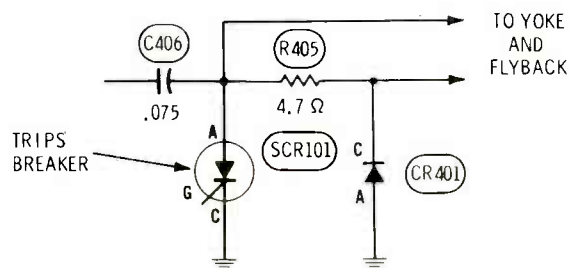

**Symptom**—Circuit breaker trips, when channels are changed  
**Cure**—Replace SCR101

Chassis—RCA CTC72  
PHOTOFACT—1439-2

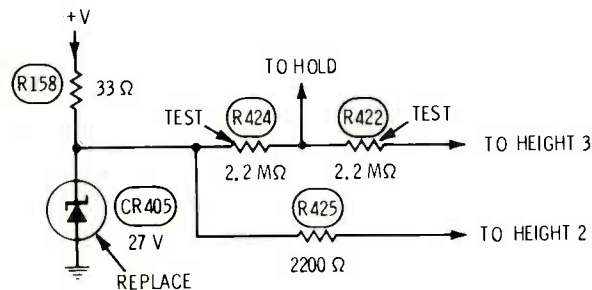

**Symptom**—No vertical sweep  
**Cure**—Check or replace CR405, R424, and R422

Chassis—RCA CTC72  
PHOTOFACT—1439-2

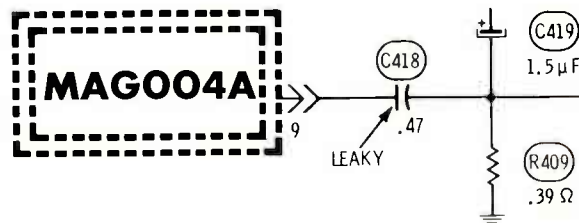

**Symptom**—Foldover at bottom, stretching at top  
**Cure**—Test or replace C418





## Until now, the toughest part of CB servicing was getting the part.

Sylvania's ECG™ semiconductor replacement line has 138 devices for the transistors, diodes, rectifiers, integrated circuits and modules you need for Citizen's Band repairs.

And they're all at your Sylvania Distributor.

That means you can spend your time in the shop instead of in search of the right parts house. It can also make the difference between turning away a potential customer, and turning out a profitable repair job.

The latest ECG Semiconductor Replacement Guide and Supplement cross-references CB devices by original manufacturer's part numbers. In practically all cases, you'll find a direct replacement, not a part that's "something like" the original.

So don't waste valuable time hunting for parts when you can have ECG's electronics supermarket right in your own shop.

We're helping you make it.

**GTE SYLVANIA**

# FAST

## COMPLETE SERVICE ON ALL MAKES OF TV TUNERS

Maximum Time In Shop 24 Hrs.

(Warranty: One Full Year)

(WE SHIP C.O.D.)  
YOU PAY SHIPPING  
**\$9.95**

Black & White  
or Color

VHF or UHF

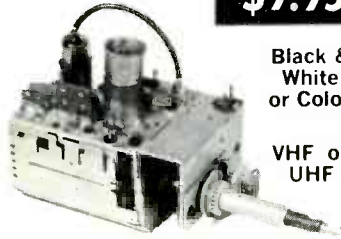

UV Combo's \$16.50

Price includes all labor and parts except Tubes, Diodes & Transistors. If combo tuner needs only one unit repaired, disassemble and ship only defective unit. Otherwise there will be a charge for a combo tuner. When sending tuners for repair, remove mounting brackets, knobs, indicator dials, remote fine tuning arrangements and remote control drive units.

### WE UNCONDITIONALLY GUARANTEE All Tuners FOR ONE FULL YEAR



All tuners are serviced by EXPERTLY TRAINED TECHNICIANS with years of experience in this specialized field. All tuners are ALIGNED TO MANUFACTURER'S SPECIFICATION on crystal controlled equipment and air checked on monitor before shipping to assure that tuner is operating properly.

## GEM CITY TUNER SERVICE

Box 6G Dabel Station  
1621 Mardon Drive  
Dayton, Ohio 45420

## troubleshootingtips

Send in your helpful tips—we pay!

### TV dead from double troubles Panasonic Model TR-425 (Photofact 1235-1)

When this "pop-up" type b-w Panasonic TV came in, it was completely dead. Not even the CRT filament seemed to be lit. The power supply was working, although the voltage was about 10% low.

Scope checks proved there was no drive to the base of the horizontal-output transistor. A new L403 driver transformer eliminated that problem.

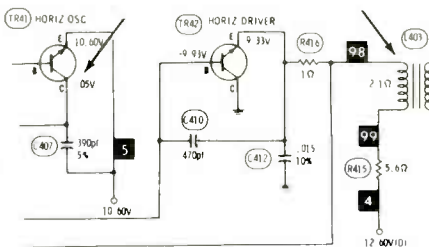

Now the raster was present, but with serious "christmas-treeing". Scope waveforms showed the frequency was too high. I checked the TR41 oscillator transistor in-circuit, and it seemed okay. All other frequency-determining components were tested so far as possible, but without success.

Finally, I replaced the oscillator transistor, and obtained normal operation. The defective transistor checked "good" on a reliable transistor tester. Questions: what defect caused the transistor to oscillate at a wrong frequency? And why didn't the transistor tester spot it?

Jordan Bier, CET  
Plantation, Florida

### Erratic hold-down operation RCA CTC71 (Photofact 1380-2)

The symptoms included an intermittent activation of the hold-down circuit (out of horizontal lock), and high voltage above 31 KV, but adjustable. The HV-adjust control required setting to the end giving minimum high voltage. Any other setting activated the hold-down circuit, throwing the horizontal out of lock.

While analyzing the DC voltages in the regulator circuit, I found that the DC voltage at the base of Q404 (error amplifier) was not changing enough when the HV-adjust control was varied. I disconnected a few resistors to obtain accurate resistance readings, and found that R404 was slightly above tolerance (2% rating).

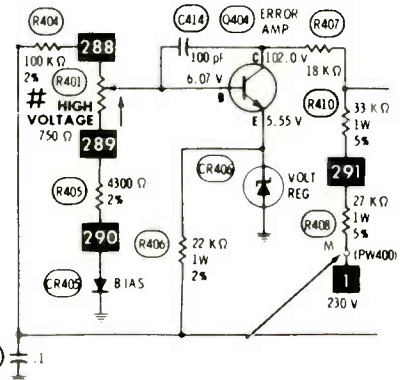

Replacement of the resistor, and proper adjustment of the high voltage, cured the problem.

Walter B. Porzueck  
Endicott, New York

### Electrical interference RCA CTC36XH (Photofact 1362-2)

This repair job, brought to me by a local dealer, should be an easy one, I thought. Video, sound, and color were perfect, but what appeared to be electrical interference was severe, especially on weaker stations.

All ground connections to the picture tube were good, and no arc of any kind could be seen or heard around the high-voltage section. My first suspect was the HV tripler. After that idea proved wrong, I pulled the chassis and connected it to a test jig, to check the picture tube and yoke. The problem remained.

At this point, I found the interference could be fine-tuned in or out, similar to color. Then I decided the problem might originate in the tuner. Before replacing the tuner, I thought I'd try a new 3HQ5 RF tube (the only plug-in component on that tuner).

Sure enough, when the tube warmed up, clearing the snow, there was no trace of "electrical interference". Can you explain what caused it?

Larry Huckeba  
Newnan, Georgia



# reader's exchange

**Needed:** Operating manual, probe and schematic for Century VTVM, Model VT-10.

Eddie Jackson  
3025 E. 111th St.  
Cleveland, Ohio 44104

**For Sale:** Kay 154C sweep generator, 50KHz to 110 MHz. Make offer; will consider dual-trace, triggered oscilloscope in trade.

James C. Arner  
6214 Pinelock Drive  
Jacksonville, Florida 32211

**Needed:** Schematic of Marlin Model MPX2000; will copy and return. Also, schematic of Monarch Model SAT 260X; need power transformer; will copy and return.

Dean's Repair Service  
201 N. Union  
Coffeyville, Kansas 67337

**For Sale:** A set of Riders Manuals (including abridged 1-5), numbers 6 through 15. Also, other old auto radio and radio-phonograph manuals, an old pre-war ACDC Detrola AM radio in wood case, a Philco pre-war chassis and speaker (working), and a large table-model wood-cabinet tube type radio (complete, but not working). Will consider all offers.

Paul Segars  
2008 4th Street North  
St. Petersburg, Florida 33704

**Wanted:** Vibrator for a 1939 Buick Sonomatic auto radio Model 1308221.

Earl G. Brown  
2 Beadart Place  
Hyde Park, New York 12538

**Needed:** Schematic and service data for a Reader's Digest digital clock radio, Model TDC-300R-D. Will buy, or copy and return.

Gerald L. Faurote  
2621 Elmwood Ave.  
Lafayette, Indiana 47904

**Needed:** Schematic for a "My Secretary" answering service, made by Bel-Air, Model MS-1. Will pay \$5.00; \$10.00 if service manual included.

Granville Electronics Service  
North Lane 2  
W. Granville, Massachusetts 01034

**Needed:** Schematic for a Calrad multimeter, Model 65-273.

Dawson L. Huff, Jr.  
NAESU USMCAS, Box 233  
FPO Seattle, Washington 98764

*(Continued on page 12)*

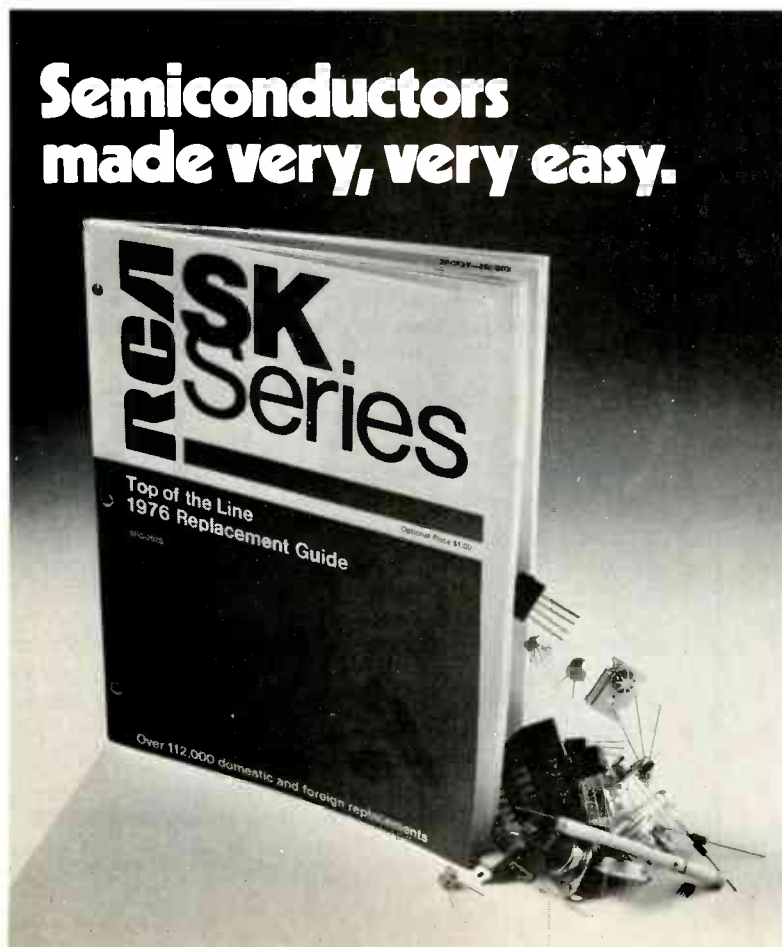

## Semiconductors made very, very easy.

**How to stock 300 instead of 112,000.** All it takes is RCA's "Top of the Line" SK Series 1976 Replacement Guide. Our most comprehensive list to date of transistors, rectifiers, thyristors and integrated circuits — 300 RCA types to replace 112,000 in entertainment or industrial equipment.

**Excellent Product. Excellent Catalog.** As a product, RCA SK replacement semiconductors measure up to strict AQL standards. As a catalog, our 1976 Replacement Guide is a thorough, accurate informational source, representing thousands of engineering man-hours.

**Get the "top of the line" now.** With RCA's SK Series and RCA's SK Replacement Guide. Contact your RCA Distributor. Or send \$1.00 (check or money order) to RCA Distributor and Special Products Division, P.O. Box 85, Runnemede, N.J. 08078.

# RCA SK Replacement Semiconductors

# If you repair foreign electronics...



## ...the GE Foreign Exchange Kit is basic.

- 24 types crossover 15,000 JEDEC numbers.
- Covers about 75% of Japanese JEDEC list for audio, TV, and CB equipment popular in the U.S.
- Lets you handle foreign units easily, quickly, and profitably.
- Handy drawer storage.
- Includes cross-reference list.
- See your authorized GE distributor for kits, individual replacements, and full details.

TUBE PRODUCTS DEPARTMENT  
GENERAL ELECTRIC COMPANY  
OWENSBORO, KENTUCKY 42301

**GENERAL**  **ELECTRIC**

(Continued from page 11)

**Needed:** Kit or factory-wired RCA VoltOmyst WV-77E.

Clifford J. Wright  
10205 Miller Rd.  
Daisy, Tennessee 37319

**For Sale:** Many older-type radio and TV tubes. Send for list.

Stewarts Radio & TV  
400 Sycamore Street  
Shenandoah, Iowa 51601

**Needed:** Schematic and service information for Accurate Instrument Genometer, Model 156. Will buy, or copy and return.

Caswell Davis, Jr.  
601 Delmar, Apt. 2  
San Antonio, Texas 78210

**Needed:** Schematic and service information for a Stewart-Warner Model R-1815-A 3-band radio. Will buy, or copy and return.

Steve A. Fahnestock, U.S.N  
525 Franklin Road  
Lexington Park, Maryland 20653

**Needed:** Schematic and manual for a Sensitive Research Model THACH, volt-amp-milliammeter, "Poly-Ranger" dynamometer AC/DC instrument. Will buy, or copy and return.

Richard B. Ely  
32-354 Camilla Circle  
Thousand Palms, California 92276

**For Sale:** Nine-month-old B&K Model 290 electronic multimeter, complete. Best reasonable offer.

David A. Day  
P.O. Box 476  
Apalachicola, Florida 32320

**Needed:** Schematic for Emerson-Rittenhouse intercom Model RM-2 all transistor radio (Probably built in early 1960's). Can copy schematic and return.

Brad Phillips  
1716 Windsor Drive  
Bloomington, Indiana 47401

**Needed:** Power transformer for a Heathkit Model 0-10 scope, either new or used.

S. C. Austin  
2845 Monogram  
Long Beach, California 90815

**Needed:** A 15-watt 50,000-ohm power rheostat for an old Sprague Model TO-3 Tel-Ohmike. Also, a meter (Model 522-46K, chrome, flush, square, 0-500 microamps) for a Model 209A Hickok VTVM.

Ray Parsons, Jr.  
RFD Portsmouth Ave.  
Stratham, New Hampshire 03885



**For Sale:** B&K Model 415 sweep and marker generator, like new, complete with all cables.

Lewis Radio and TV  
Route 1  
Central City, Nebraska 68826

**Needed:** Schematic and service manual for Precision Apparatus signal generator Type E200 or E200C.

J. J. Bobrow  
827-12th Street  
Santa Monica, California 90403

**Needed:** Schematic and service manual for Vernon Model 47/26 tape recorder, manufactured by OKI Electric Industry.

David E. Spickard Company  
3060 Portsmouth Avenue  
Cincinnati, Ohio 45208

**Needed:** Service manual for a Precision Apparatus Model E-200-C RF signal generator.

Franklin Hawkes  
U.S. Route 302,  
Highland Lake Corner  
Westbrook, Maine 04092

**For Sale:** B&K Model 1246 Digital-IC color generator, excellent condition, one-year old. Best offer.

John Fitzpatrick  
138 Westfield Rd.  
Holyoke, Maine 01040

**For Sale:** Eico Model 369 TV/FM sweep generator and post-injection marker, like-new. \$125, or highest bidder.

Walter A. Wilson  
527 Amethyst St.  
Cape Girardeau, Missouri 63701

**Needed:** Schematics or service manuals for a Sears Silvertone b-w chassis 528.712214, and an AM/FM receiver Sears Silvertone chassis 528.54730. Will buy, or copy and return.

Georgé Paulik  
Skyway Electronics  
P.O. Box 66  
Manistee, Michigan 49660

**Needed:** Company address, or suitable part number substitute for Symphonette power transformer PTH-57003U. Also, need schematic for Lexington stereo music system Model LE-3 manufactured in Japan. Any information will be appreciated.

Edgar R. France  
Lot #13 VHFS  
Warrenton, Virginia 22186

(Continued on page 14)

# The 5 SECOND TUNER RESTORER



**CLEANS!  
LUBRICATES!  
POLISHES!**

Spray TUN-O-POWER on tuner contacts, rotate the tuner and *within 5 seconds* you get beautiful color pictures on all channels. It's a minor miracle!

TUN-O-POWER is the most powerful polisher and lubricant ever developed. It works so well, you use a lot less. You can spray twice as many tuners with TUN-O-POWER as you can with an ordinary cleaner/lubricant.

What's more, TUN-O-POWER lubricant lasts for months longer than ordinary sprays. Detent action stays smooth as silk so you never have to worry about callbacks.

**CHEMTRONICS  
INCORPORATED**

45 HOFFMAN AVE., HAUPPAUGE, N.Y. 11787 • (516) 582-3322

Our business is improving yours!

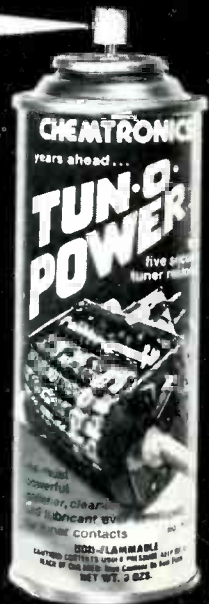

## WE'RE ON TRIAL

**But, you're the judge.**

To introduce you to Dana's quality tested Danameter® 2000A we're offering you a **thirty day free trial** period to use our DVM and judge its new reliable features. If it doesn't fit your needs, return it...that's right, return it. Why make such a fantastic offer? Just look at what the Danameter 2000A offers!



- Unequaled accuracy
  - New brighter, faster "Super" LCD (reads even in sunlight)
  - Direct answers, no time-consuming calculating
  - 1 full year battery life
  - LSI-CMOS circuitry
- And best of all...it costs only \$199.50!

Send for more details now...put us on trial. The new Danameter 2000A will come out ahead! For immediate action, call Cliff Hamilton at 714/833-1234.

**DANA**  
Others measure by us.

For More Details Circle (8) on Reply Card

# the bright one

new phosphor picture tube  
with twice the brightness

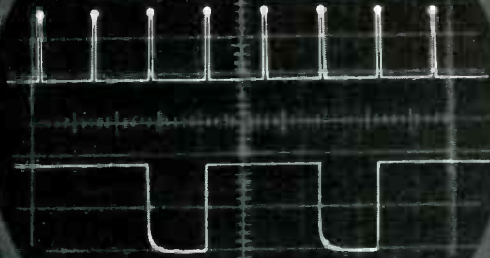

## TO-60 automatic dual-trace triggered-sweep oscilloscope

P-31 phosphor CRT has double the brightness for bright displays even in high speed dual-trace modes. Bandwidth: DC to 15 mhz. Unique features for the industry's greatest value are: • Automatic Triggering • Automatic Astigmatism • Automatic Horizontal Sweep • Automatic Horiz/Vert. TV Triggering provides positive display on composite video signals. Vertical sensitivity: .01 volts/cm to 20 volts/cm in 1-2-5 step sequence. Horizontal Sweep Speeds: .2 sec/cm to .5 $\mu$  sec/cm in 1-2-5 step sequence. Has 5X magnifier at all sweep speeds. External Horiz. Amp. Bandwidth: DC to .5 mhz; Sensitivity: .5 volts/cm. Calibrated Test Signal: 1 volt P-P square wave. Power: 105-125 volts, 60 cycles, 65 watts

Model TO-60 Less Probes. Net ..... \$489.50

TO-55 automatic single-trace triggered sweep oscilloscope. Features same as TO-60 except Vert. Bandwidth is DC to 10 mhz.

Model TO-55 Less Probes. Net ..... \$379.50

For the "bright one," see your distributor, or write:



### LECTROTECH, INC.

5810 N. Western Avenue, Chicago, Illinois 60659  
Area (312) 769-6262

For More Details Circle (11) on Reply Card

**For Sale:** Many hard-to-find radio tubes, parts, and books. Write for list.

T. Wojciechowski  
101-45 94th Street  
Ozone Park, New York 11416

**Needed:** Erase head for Heathkit tape recorder, Model TR-1E.

Robert Verreault  
436 Place-Marchand  
Matane P. Quebec  
Canada G4W 2J8

**Needed:** Power transformer, part number 80B-61-1 for Admiral combination hi-fi amplifier, Chassis 6D3.

Elmer L. Mosley  
1609 Pine Street  
Kenova, West Virginia 25530

**Needed:** Power transformer, part number 14-62 for Jackson TV, Model G-2.

Albert Hopkins  
Route 1, Box 231-A  
Diamond, Missouri 64840

**Needed:** Schematic, manual or any information about a Sun Mark black-and-white portable transistor TV, Model SM-12TV.

Danny Klecka  
3379 Marbury Drive  
St. Louis, Missouri 63129

**Needed:** Someone to record two spools of recording wire to cassette. Spool measures 2-3/4 inches outside with 1-5/8 inch hole. Will cover all shipping and expenses.

Joe Omen  
400 North Fourth Avenue  
Tucson, Arizona 85705

**Needed:** The following plug-in coil assemblies for National Communications receiver, Model HRO-50R: AA 27-30 MHz, AB 25-35 MHz, AC 21-21.5 MHz, E 900-2000 KHz, F 500-900 KHz.

Byron E. Sauve  
16270 West 13th Avenue  
Golden, Colorado 80401

**For Sale:** One B&K sweep-and-marker generator, Model 415. Will sell for \$359.00 or best offer. Also have a Knight oscilloscope and RF generator for sale.

Pedro J. Taboada  
Box 1034  
El Paso, Texas 79946

**Needed:** Operating manual for Heathkit TV alignment generator, Model TS-4A. Will buy, or pay for copy.

Gabe's TV  
12230 Klingerman Street  
El Monte, California 91732

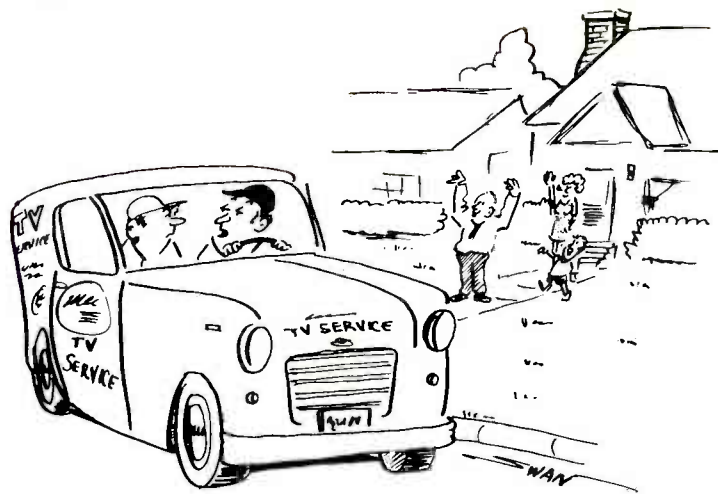

"This must be the place."

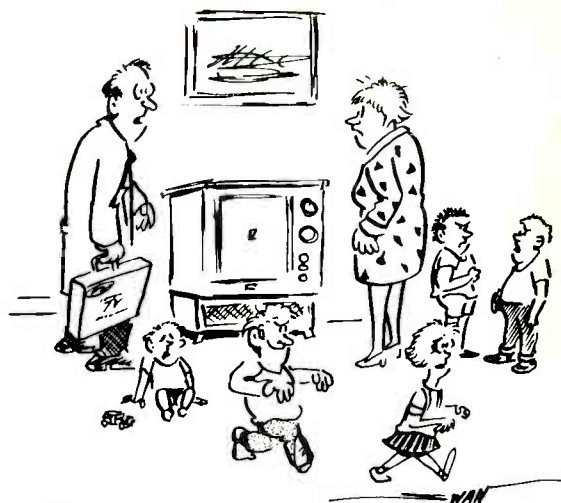

"Please stop shouting 'Money is no object'— I'll fix it as fast as I can!"

# Man's Best Friend... His TV!

By Terry L. Turner

Recently, I moved from the rat race of Los Angeles to the quiet of a small midwestern town, where I opened a TV repair shop. In California, I worked in the engineering department of a large electronic manufacturing company, and also helped part-time as a bench man for several TV shops. None of these activities required me to deal directly with the public; but now, in my own shop, I have daily contact with those strange creatures commonly known as "customers".

Through these daily contacts, I have learned that Man and TV are one entity. Any attempt to separate them, even temporarily, can result in anguish for the set owner, and much ill will for you, the villain.

## No Loaner

For example, consider the case of a man who was one of my first customers. At that time, I hadn't learned about the special bond between Man and TV, so I bluntly told him that I couldn't repair his set there, but would have to take it to the shop.

"Take it to the shop?" he repeated, as though having difficulty in understanding the words. "Yes sir, I'm afraid so." He looked down at the ailing set and asked in a quiet voice, as though he didn't want it to hear, "Do you have a TV I could use while mine is being fixed?" "No, Mr. Brown, I'm sorry. I'm just getting started and haven't gotten any loaners yet." Reluctant-

ly, he allowed me to take his receiver away.

The next day, Mr. Brown came to the shop wanting to know how the repairs were going. "Well, I really haven't had a chance to check it yet", I explained. I thought I was being very polite, because I had picked up the set about 5:30 PM, and now it was only 8:05 AM the following morning.

Then the telephone rang. "Excuse me, Mr. Brown," I said as I went to the phone. When I hung up, I looked around and thought he had gone. But then I saw him, sitting by the front window, with the most forlorn and sad look I have ever seen on a human being. "Uh...Mr. Brown?" He looked up. "Yes?" "I just received a new portable TV this morning. Would you like to take it home with you until I finish yours?" His eyes brightened and his face glowed, as he took the portable and rushed through the door. A few days later, I was able to reunite him with his beloved TV, and all was back to normal.

## The Big Game

Sometimes the separation of Man and "boob tube" can result in near violence. Not long ago, the front shop door opened and 6' 4", 300-pound Mr. Smith walked in. "I want my TV," he said, pounding his ham-like fist on the counter. "I...uh..." I stammered as I looked up at the menacing figure. "When

will it be ready?" he asked with his huge face almost touching mine.

"Uh...very soon. I'm right on top of the problem. It's just a matter of time. Oh, by the way, I hear you used to play football for State U." "Yeah, that's right. I was the best tackle they ever had," he said, straightening up and throwing back his shoulders. "Someone started to tell me about that big game you were in, but I didn't get to hear the finish." "Must have been in '49 against Fairbury Tech." "Yes, that was it," I lied.

Actually, I hadn't heard anything about the game, but figured every football player **must** have had at least **one** big game. Mr. Smith proceeded to describe every play; and by the end of the story, he had calmed down. Fortunately, I was able to return his TV soon afterwards.

## While He Watches

Another type of customer is the one who refuses to be separated from his TV, no matter what.

"You busy?" I looked up from the ancient b-w console I was working on, past the sea of sets waiting to be repaired, and on to the doorway. This elderly man was carrying a 12" GE portable that was missing the channel-selector knob and the tip of the built-in antenna.

"Well, yes, I am," I replied. "But what can I do for you?" "Oh, me and the missus were watching



# BOOST your TV service profits with the NEW Heathkit CRT Tester/Rejuvenator



The NEW IT-5230 CRT tester/rejuvenator adds versatility to your service bench. You can check, "clean" and rejuvenate virtually every TV picture tube available including NEW IN-LINE GUN CRT's without adaptors! It's portable, practical and priced right...you NEED it on your bench!

Kit IT-5230, Shpg. wt. 10 lbs. . . . . 89.95  
Assembled ST-5230 . . . . . 140.00

TE-333

## Write for FREE Catalog

Heath Company, Dept. 25-15  
Benton Harbor, Michigan 49022



For More Details Circle (9) on Reply Card

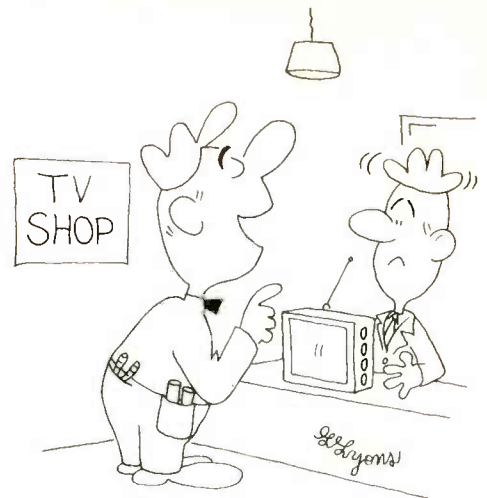

"Instant repairs, no! The only thing instant around here is our coffee!"

Lawrence Welk, and right in the middle of Myron Floren's solo, the picture went haywire. It's probably just a tube."

After a few more questions and answers indicated the problem was a loss of horizontal hold, I explained that he would have to leave the set, and I would repair it as soon as possible. Mr. Jones was polite, but obviously disappointed. Finally, he decided to "take it somewhere else". I knew the nearest other shop (10 miles away) was even busier than mine, so I wasn't surprised next day when he returned.

This time I chickened, and worked on the set while he watched. Boy, did he watch! His head almost touched mine as we both peered in the back of the TV. Now, it wouldn't have been so bad, but Mr. Jones had a severe case of asthma. Believe me, it's not easy to troubleshoot logically with 100 dB of wheezing in your ear.

In spite of the interference, I found the defect (which was "just a tube"), and sent Man and TV back home for more companionship.

### Advice

These are just a few of the examples that have convinced me of the tight and almost unbreakable bond between Man and his TV. So, the next time you must separate a customer and his precious set, do it gently; you wouldn't want to hurt him...too much.

## The "New Generation" Flat-Rate Pricing...

is proving itself in thousands of shops from coast to coast—it prices your work profitably while creating customer good-will.

Fast tab indexing to 19 major repair categories prices all bench, home and over-the-counter repairs with authority.

## tv & radio tech's guide to pricing



**Professional**  
6 x 9 hard cover,  
steel ring-bound  
edition....  
\$18.95 ea. post pd.



**Satellite Edition...**  
the same system described  
above, only reduced to  
shirt-pocket size for  
outside service...  
\$16.95 ea. post pd.  
Quantity prices available.

### Plus, Computerized Pocket-Size Parts Catalog.

Customized to your desired parts profit. Lists over 3500 most-used parts, continually up-dated. Can easily recover initial investment in less than 30 days... \$75.00 plus \$10.00 per catalog.

P.O. Box 5234  
Lincoln, NE 68505

**sperry tech inc.**

\_\_\_\_ copies, Hardbound. \_\_\_\_ copies, Satellite  
\_\_\_\_ copies, Parts Catalog.  More information  
\_\_\_\_ Amount enclosed, check or money order.  
(NE res. add sales tax)

NAME \_\_\_\_\_  
CO. \_\_\_\_\_  
ADDRESS \_\_\_\_\_  
CITY \_\_\_\_\_  
STATE \_\_\_\_\_ ZIP \_\_\_\_\_

# Find semiconductors fast.



With the new, updated Mallory PTC Semiconductor Product Guide.

Instead of looking all over for replacement semiconductors, just open the guide.

There's new indexing and cataloging for fast, easy access to the electrical and physical parameters of each PTC product. Plus, a listing of thousands of semiconductors, each cross-referenced to Mallory PTCs.

It's the authoritative source-book and cross-reference for transistors, zener diodes, diodes, high-voltage rectifiers, color crystals, integrated circuits, field-effect transistors.

Now it's easier than ever to get Mallory performance and reliability in your semiconductor replacement parts.

See your Mallory distributor or give him a call, today.

## MALLORY

### MALLORY DISTRIBUTOR PRODUCTS COMPANY

a division of P. R. MALLORY & CO. INC.  
Box 1284, Indianapolis, Indiana 46206; Telephone: 317-856-3731

Batteries • Capacitors • Controls • Security Products • DURATAPE® • Resistors • Semiconductors • SONALERT® • Switches • Fastening Devices  
DURATAPE® and SONALERT® are registered trademarks of P. R. Mallory & Co. Inc.

# COLOR CASEBOOK



Here are more case histories and suggested techniques to help you repair color-TV receivers.

By Robert L. Goodman, CET

## Case #1: Fading Video

### Symptoms

The video slowly faded and the brightness increased. After the General Electric with the 16QA chassis (Photofact 1405-1) had oper-



Fig. 1 The main visual symptom was a bright raster without any picture. Other video troubles can black out the screen. Whatever the brightness condition, it can provide valuable clues about where to look.

ated for a few minutes, the screen showed only a blank, bright raster with retrace lines (Figure 1).

### Preliminary analysis

Sound and color changed very little during the fading contrast, so it seemed certain the defect was in one of the video stages.

Six video stages are used in this model, if you count the color outputs where the three color signals and the video are matrixed. Two stages can be eliminated from suspicion, because they handle both color and video, and only the video fades. Video and chroma travel together to the collector of Q104, the first video transistor, where the chroma is picked off; and the color output transistors handle both color and video. Any of the remaining four stages can cause simultaneous changes of contrast and brightness without affecting the color and sound.

All of the video stages are direct coupled, except for one coupling capacitor between Q106, the second video amplifier, and the third video transistor, Q108. However, the effects of direct coupling are obtained

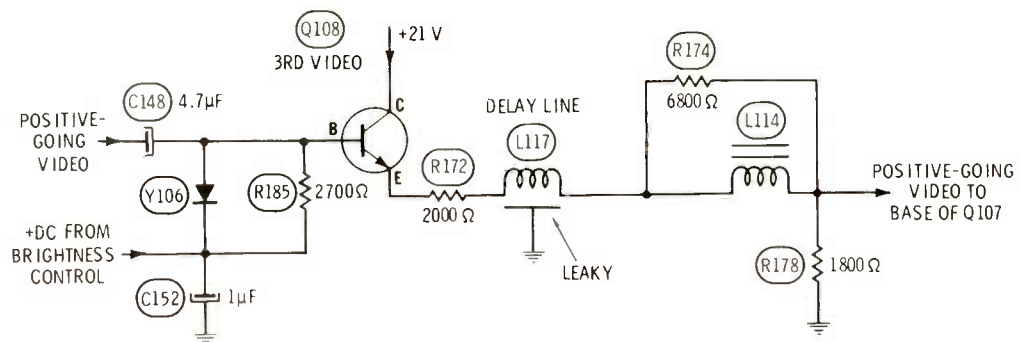

Fig. 2 Reduction of signal and DC voltages at the delay line helped pinpoint the defect in a 16QA General Electric.



by diode Y106 which acts as a DC restorer to make the base of Q108 more positive when the video level increases (Figure 2).

### Testing techniques

When all the video stages are AC coupled, a fast and accurate technique is to analyze the DC voltages of each tube or transistor. But with DC coupling between stages, usually all DC voltages following the defect are wrong. Therefore, DC analysis is not the best method here.

As next choice, I prefer to use my dual-trace scope, with DC coupling and the probes connected to input and output of each stage in turn. This tests both the DC and AC voltages in each measurement, and the dual-trace monitors the signals at two points, thus saving time.

The first drifting reading happened at the third video amplifier, Q108. Base voltage was stable, but the emitter voltage went down slightly. The change of emitter voltage was so small, I decided to test one more stage. Both the DC and AC video voltages at the base of Q107 decreased more than the emitter of Q108 had.

Evidently the defect was **between** the emitter of Q108 and the base of Q107, and only five components were there.

### Defective component

After much heat testing, moving the components, and unsoldering them for ohmmeter tests, I discovered leakage in L117 delay line. Most delay-line defects are opens, but this line developed leakage from coil to the ground foil, and the leakage reduced both the video

and the positive DC at the base of Q107.

Only one polarity-inverting stage is located between the delay line and the grids of the picture tube. Therefore, a decreased positive voltage at the delay line caused the picture-tube grids to become more positive, giving a brighter raster.

## Case #2: Tripping Breaker

### Symptoms

The circuit breaker of a C1-chassis General Electric color TV (Photofact 1100-2) had tripped, eliminating both raster and sound. When the breaker was reset, it would trip again after about five seconds.

### Preliminary analysis

An overload of this magnitude is likely to originate only in the B+ power supply, or in the horizontal-

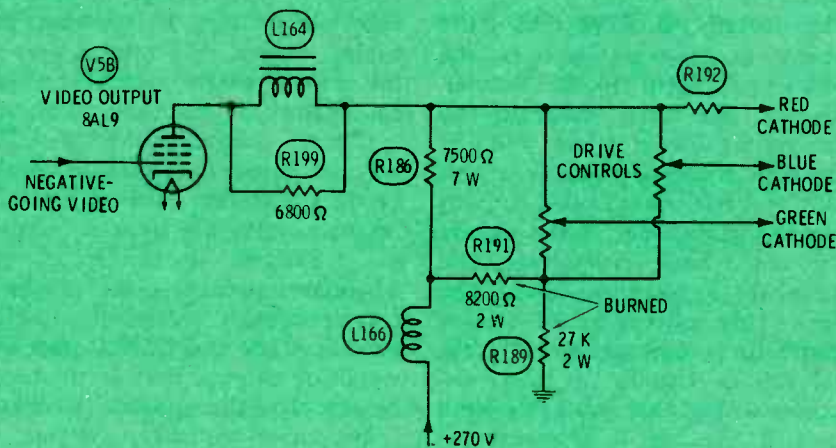

Fig. 3 When they are overloaded sufficiently, carbon-composition resistors can become near-shorts. Usually they will appear discolored from the excessive temperature, as these were in the General Electric C1.

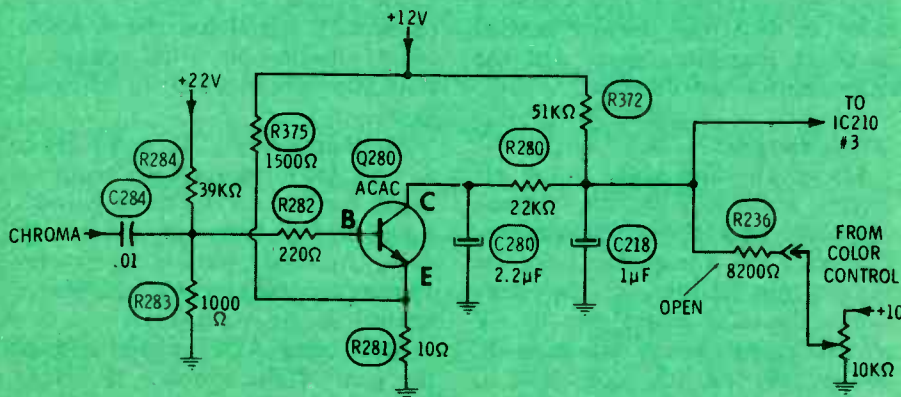
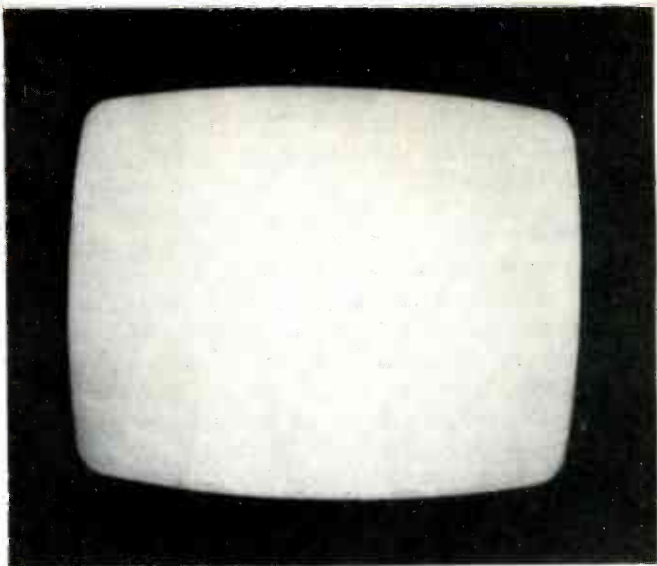

Fig. 4 Operation of the new GE ACAC circuit is described in the text. The DC voltage at pin #3 of IC210 determines the color saturation. An open R236 made it impossible to turn down the color.

**Fig. 5** A defective video stage was indicated by a low-contrast picture, with good sound, color, and sweep locking.



output stage. According to the schematic, tubes are used for nearly all functions, with transistors operating in the sync and AGC stages.

None of the tubes could have warmed sufficiently in five seconds to draw such an excessive current, and it seemed unlikely that a low-level transistor could draw so much current at any time.

Of these suspects, only the B+ remained in question.

When checking for shorts across a power supply that feeds transistors, you should be sure the polarity of ohmmeter voltage reverse biases the base/collector junction of all transistors. In this case, the positive ohmmeter lead should go to B+ and the negative to ground (of course, that's also the correct polarity for the filter capacitors).

#### Defective components

The main +270-volt supply measured less than 1000 ohms, proving that excessive leakage there was causing the overload.

After opening several branches of the B+ supply, I pinpointed the short in the area around the plate of the video amplifier. Now that my attention was focussed there, I could see both R191 and R189 were burned (Figure 3).

I replaced the two defective resistors and resoldered the B+ leads that had been opened during the search, then the receiver came to life.

#### Comments

Resistors don't often burn unless another component has overloaded them. But in this case, either R191 or R189 lost resistance because of

the heat. That applied more B+ to the other resistor, which in turn heated excessively and lost resistance. And so the sequence continued, with each decrease of resistance overloading the other component even more, until finally both resistors were burned to near shorts.

Incidentally, if R191 and R189 increase in resistance, or open, the picture will seem to be normal. However, the drive controls will have no significant effect, and the gray-scale tracking probably will be poor. If L166 should open for any reason, the cathodes of the picture tube would have zero voltage, and the grids remain positive. The picture tube current would become several times normal, and kill the high voltage. Usually the raster disappears so fast that you can't see it leave, if the coil is intermittently open.

#### Case #3: Excessive Color

##### Symptoms

The General Electric 17YA chassis (Photofact 1495-1) had excessive color. In fact, the chroma seemed to be at maximum gain, and the color control had no effect.

##### Circuit analysis

Many all-solid-state color receivers have IC's in the chroma channel, and the color control changes a DC voltage that's applied to one pin of the IC. In other words, the color control has no AC chroma signal, but it adjusts a DC voltage of the IC, and the IC internally adjusts the gain. So it is in the GE YA chassis.

But there's one difference. A

special type of automatic color level control, called Automatic-Chroma-Averaging-Circuit or ACAC, also affects the DC voltage from the color control.

Figure 4 gives the circuit of the ACAC (sometimes nicknamed ack-ack) stage. Q280 is biased just at cut-off by the voltage dividers at base and emitter. In addition, the supply marked +12 volts is part of the picture-control circuit, which can change the exact cut-off point.

Chroma coming in through C284 acts as bias. The positive peaks produce collector current, and the negative peaks are ignored because the transistor already is cut-off. Therefore, stronger color causes a correspondingly increased collector current. C280 and C218 bypass any ripple of chroma that is produced by this class-B amplitude detection.

Increased collector current of Q280 (because of stronger chroma IF signal) decreases the positive DC voltage (coming from R372 and R236) at pin number 3 of IC210, and this reduces the chroma gain inside IC210. Of course, a weaker chroma IF signal has the opposite effect, allowing pin 3 DC voltage to rise and produce more chroma gain.

Another use for C280 and C218 is to slow down the voltage change so rapid, normal variations of chroma signal do not change the chroma IF gain. Instead, only longer-term average chroma signal level changes control the ACAC action.

Most other ACC circuits control the gain of the chroma IF stages according to the amplitude of the burst, which is supposed to be the same at all times. However, the

burst amplitude is **not** always the same as it is broadcast by some TV stations. It's possible, therefore, for wrong burst amplitude to produce excessive or insufficient color at times. Evidently, the ACAC circuit was designed to minimize such problems.

#### Troubleshooting

DC voltage at pin #3 of IC210 was slightly high, and it did not change as the color control was rotated. At the color control, the DC reading changed normally. This was proof that the defect was between those two points, and the only component between them was R236. After R236 was removed from the circuit, it measured open, and a new one enabled the color

control to reduce the color saturation.

#### Case #4: Weak Contrast Symptoms

Strong color, normal sound, and a bright raster with very little contrast were the symptoms of the General Electric C1 chassis (Photofact 1231-2), as shown in Figure 5.

#### Preliminary analysis

When tuned to a blank channel, the receiver showed weak snow, just as it had showed low contrast with a station. On channel, the vertical and horizontal locked as they should. All of these symptoms pointed towards a weak video-amplifier stage following Q301, where the sync and chroma signals were obtained.

#### Circuit analysis

Figure 6 gives a schematic of the first and second video stages, plus the delay line and blanker. Negative-going video is developed at the emitter of Q301, the first video amplifier; from there the chroma signal is coupled through C501 to the chroma take-off coil.

Positive-going video comes from the collector of Q301, and it is fed to the base of the sync amplifier and the base of Q304, the second video amplifier. This transistor gives very little gain, because the emitter resistor is not bypassed, and a small-value resistor is used at the collector.

Q304 has a gain of about 1, because of the unbypassed emitter resistor and the small-value collector

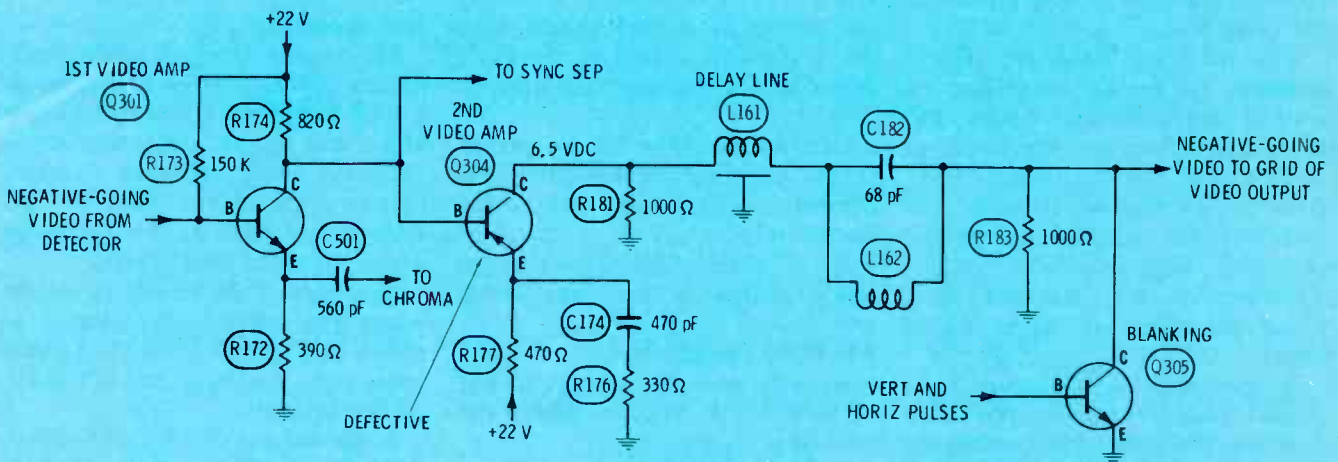

Fig. 6 DC coupling of all video stages is employed in the C2/L1 General Electric. Many video defects change the brightness level, and so the amount of brightness can be a valuable symptom.

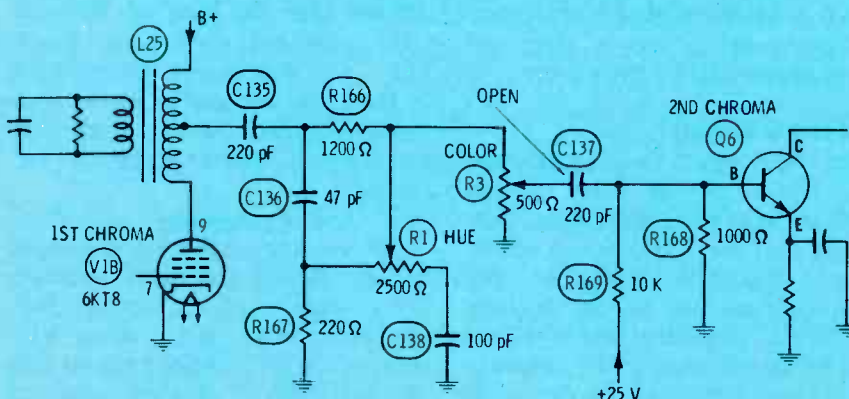

Fig. 7 An excellent way to find a loss of color is to use a scope to trace the progress of the pulses of a color-bar pattern. In the Zenith 15Y6C15, the color signal was normal at the color control, but was missing at the base of Q6 because C137 was open.



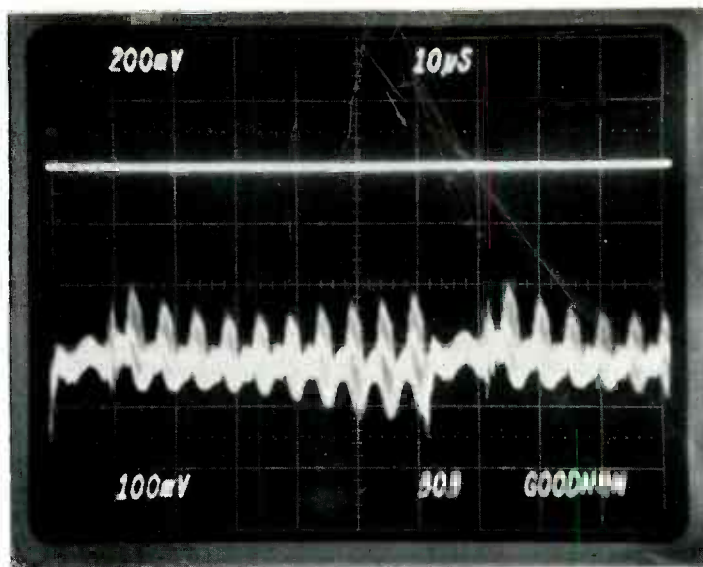

Fig. 8 The top scope trace shows no signal at the base of Q6, while the trace at the bottom shows a normal "comb" pattern at the plate of the first-bandpass tube. Color was lost between those two points.

resistors. R181 and R183 each have a value of 1000 ohms to prevent standing waves (a type of ghosts) in the delay line.

The blanking transistor (Q305) appears to be an amplifier of vertical and horizontal pulses that after amplification are used to supplement the blanking pulses from the TV station. However, the transistor has no bias except the incoming large-amplitude pulses. Therefore, it functions not as a linear amplifier, but as an on-off switch.

A positive-going vertical or horizontal pulse reaching the base saturates the transistor, causing the collector/emitter path to ground all signal and DC voltages at the output of the delay line. After inversion by the video-output tube, each temporary "ground" becomes a positive-going pulse at the cathodes of the picture tube, thus eliminating all brightness for the duration of the pulse.

#### Troubleshooting

In this chassis, all three video stages are direct coupled, so one method of troubleshooting is based on whether the raster brightness is excessive or too dark.

For example, a black raster can be caused by:

- a B/E or E/C short in Q301;
- an open in Q304 from collector-to-emitter or from base-to-emitter;
- a C/E short in Q305 blanker transistor; and
- an open delay line or L162.

Here are other tests that can be

made, plus other defects and symptoms:

- If a raster can be seen, adjusting the brightness control should vary the brightness, otherwise there's a defect in the video-output tube or circuit;
- Shorting the delay line to ground should decrease the brightness, if the circuit is okay from there to the picture tube;
- A C/E short in Q304 gives excessive brightness without any video; and
- If Q305 blanker is open, the picture will not be affected, but retrace lines appear when the vertical is rolling.

In this case, scope waveforms showed strong blanking pulses at the delay line, but very little video. When Q304 transistor was replaced, the performance became normal.

#### Case #5: No Color

##### Symptoms

The Zenith 15Y6C15 (Photofact 983-2) produced a good b-w picture. Unfortunately, it was a color receiver that wouldn't show color.

##### Preliminary analysis

Far too often, we technicians look for a loss of color in the chroma bandpass amplifiers, forgetting that the 3.58-MHz carrier is equally important. Therefore, any complete analysis should include the burst amplifier, color killer, 3.58-MHz oscillator, color demodulators, and bandpass amplifiers. A complete loss of color seldom is caused by poor picture-IF align-

ment (even then, the b-w picture indicates something is wrong).

#### Troubleshooting

My favorite method with complaints of loss of color is to tune in a color bar pattern, defeat the color killer, and use my dual-trace scope to locate where the color "comb" pattern stops. Then I check the DC voltages and resistances in the stage where the color disappeared.

The part of the bandpass circuit where the trouble was located is shown in Figure 7. I was lucky this time, and came close to the trouble on the first try.

A normal set of color-bar pulses were found at the plate of V1B (lower trace in Figure 8), but no signal at the base of Q6, the second-chroma amplifier (top trace of Figure 8). That proved the loss of color was somewhere between those two points. Color pulses were found at the top and center lugs of the color control. Between the color control and the base of Q6 was C137 and the connecting wires. Yes, C137 was open. Replacement of the capacitor and a touchup of the adjustments finished a job that had seemed difficult before it was started.

#### Comments

No one troubleshooting technique can be fastest and most accurate for all defects in all models. But, the ones most often used with success are DC voltage analysis and the operation of a good scope to show the actual waveforms and serve as a signal-tracer. □

# Servicing Stereo Audio Systems

Part 7/By Carl H. Babcoke, CET

Basic audio theory and other facts about stereo audio systems have been included in the preceding six articles of this series. About 20 percent of the questions in the journeyman audio CET test involve fundamentals similar to these. In this article, we are presenting a multiple-choice review test. After you have taken the test, grade yourself by the answers given on another page.

## Taking The Test

These are not "trick" questions, such as ones with two right answers or no right answers. Ignore non-typical or special cases; instead answer according to what is true in general.

Circle the (A) or (B) that's before the answer you choose. The page number for the answers is listed at the end of the test.

## Audio Review Test

1. What is the major difference between a volume control and a loudness control?:

(A) A loudness control is used in low-priced equipment (such as a child's record player), but a volume control is used exclusively in high-priced equipment.

(B) Loudness controls change both loudness and frequency response, while volume controls change only the loudness.

2. Thermal-agitation noise is caused by current flowing through a semiconductor material. It also is called:

(A) partition noise.

(B) Johnson noise.

3. Three types of four-channel stereo systems are matrix, imitation, and:

(A) capacitive discharge.

(B) discrete.

4. Which of the circuits in Figure 1 is a low-pass filter?:

(A) the circuit of Figure 1A.

(B) the circuit of Figure 1B.

5. Which is more desirable in a phonograph cartridge?:

(A) high compliance.

(B) low compliance.

6. Transient distortion is most likely to occur in:

(A) a preamplifier.

(B) a speaker.

7. A de-emphasis circuit is used in:

(A) an FM receiver.

(B) an FM transmitter.

8. In Figure 2, a likely cause of a thickening of the peaks of the sine wave is:

(A) flicker noise.

(B) parasitic oscillation.

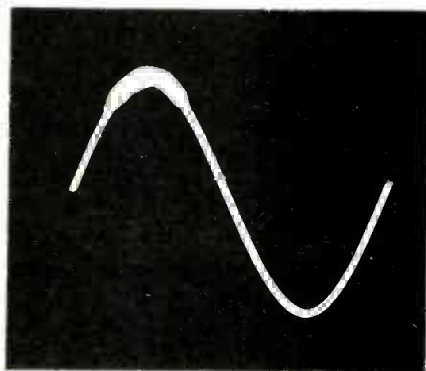

Figure 2

9. Which of these types has the higher amplitude of output signal when playing the same phonograph record?:

(A) a ceramic cartridge.

(B) a magnetic cartridge.

10. In order to record good high-frequency response, the gap of a recording head should be:

(A) wide.

(B) narrow.

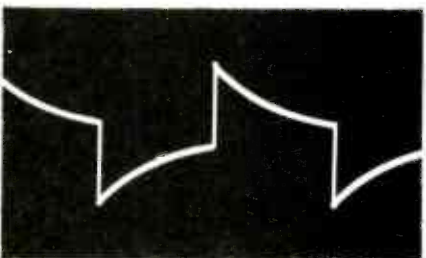

Figure 3

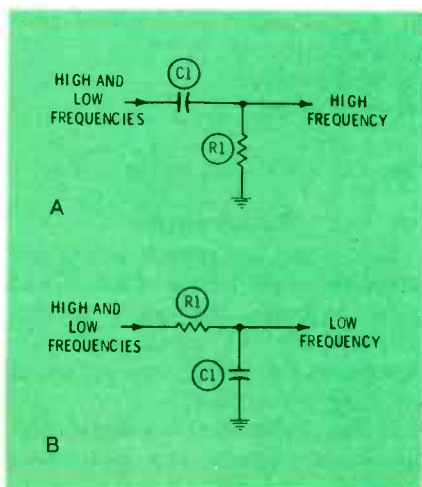

Figure 1

11. Degaussing is:  
 (A) demagnetizing the tape-player head.  
 (B) reduction of azimuth distortion.
12. During a square-wave test of an audio amplifier, the scope waveform of Figure 3 indicates:  
 (A) poor low-frequency response.  
 (B) poor high-frequency response.

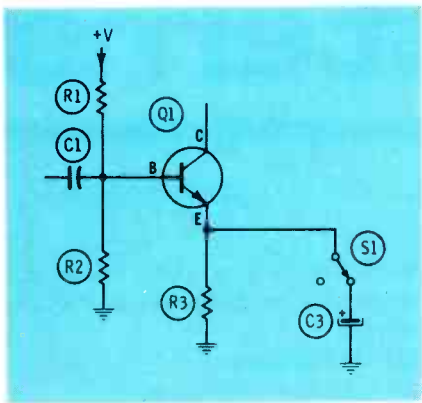

Figure 4

13. The bend of a record player tone arm is designed to:  
 (A) reduce vertical tracking force.  
 (B) reduce horizontal tracking error.
14. Ringing on the top and bottom of a square wave indicates:  
 (A) phase-shift distortion.  
 (B) a peak in the high-frequency response.
15. Crystal cartridges in modern disc record players use:  
 (A) Rochelle salt crystals.  
 (B) ceramic crystals.
16. In Figure 4, selecting a large value of emitter capacitor (C3) will:  
 (A) increase the gain of the stage.  
 (B) decrease the gain of the stage.
17. Most circuits and parts values that increase the gain of an amplifier also:  
 (A) increase (widen) the bandwidth.  
 (B) decrease (narrow) the bandwidth.
18. In Figure 5, the tape-head gap is not properly aligned with the track. The type of adjustment needed is:  
 (A) azimuth.  
 (B) height.
19. A pre-amp and equalizer are

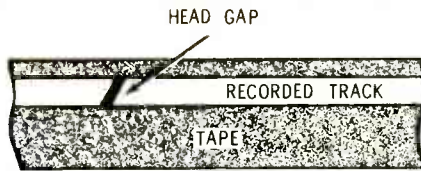

Figure 5

used to process the output signal of:  
 (A) a ceramic phono cartridge.  
 (B) a magnetic phono cartridge.

20. Figure 6 illustrates:  
 (A) Doppler distortion.  
 (B) crossover distortion.

21. Equalization is used in audio systems to:  
 (A) restore the frequency response, compensating for any undesired changes caused by the transmission or recording of sound.  
 (B) maintain a constant output voltage, so the output power is independent of the amplifier gain.

22. Which characteristic is more desirable?:  
 (A) a low damping factor.  
 (B) a high damping factor.

23. Which of these statements is correct?:  
 (A) Ceramic cartridges have a "constant-amplitude" frequency response, and magnetic cartridges have a "constant-velocity" response.  
 (B) Ceramic cartridges have a "constant-velocity" frequency response, and magnetic cartridges have a "constant-amplitude" response.

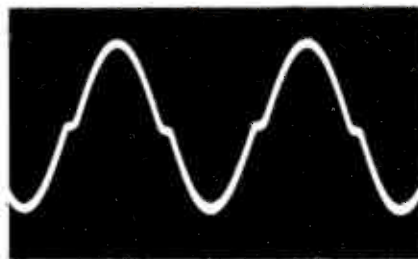

Figure 6

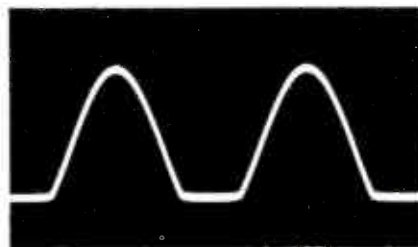

Figure 7

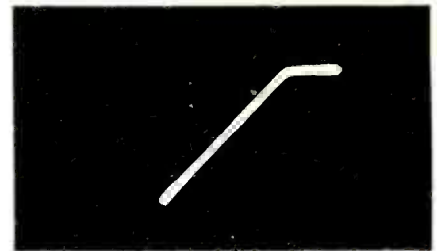

Figure 8

24. The type of clipping distortion shown in Figure 7 is likely to be caused by:  
 (A) incorrect bias.  
 (B) a non-linear transfer curve.
25. If a shielded cable is run between two chassis, lower noise and hum usually is produced when:  
 (A) the shield is grounded only to one chassis.  
 (B) the shield is grounded to both chassis.
26. Almost everything that's done to increase the gain of an amplifier also:  
 (A) increases its noise.  
 (B) decreases its noise.
27. The second harmonic of a 1000 Hz pure sine wave:  
 (A) does not exist.  
 (B) has a frequency of 2000 Hz.
28. In a tape playback system, equalization normally is accomplished:  
 (A) in the power amplifier.  
 (B) in the pre-amplifier.
29. The lissajous pattern of Figure 8 indicates:  
 (A) clipping.  
 (B) rolloff.
30. An example of low-frequency noise is:  
 (A) white noise.  
 (B) pink noise.

Answers are found on page 53.

### Comments

This is the last installment of the series about the basics of audio and stereo systems. We plan another series which will cover more advanced audio principles, including servicing procedures.

In the meantime, we invite your comments about the preceding material, and your suggestions of areas to be studied next. □



# MEDICAL ELECTRONICS NOTEBOOK

## Part 3



By Ed Bukstein

*A technician working with any item of medical-electronic equipment should know the correct name, how to pronounce it, and what the instrument is used for. These explanations complete the list which was started several months ago.*

Suppose a doctor called you to his office to repair the **electrocardiograph**. You certainly can't afford the embarrassment of asking, "What's an electrocardiograph?"

Medical science is notorious for the overabundant use of prefixes, suffixes, and compound words that produce such tongue-twisters as "electroencephalograph" and "phonocardiography". Any technician working with medical-electronic equipment must know what each instrument does and the correct name for it.

After you finally get inside the instruments, you'll feel on familiar ground. A diode is a diode whether it's in an audio amplifier or a "defibrillator". And repairing a medical oscilloscope is no more difficult than working on a TV receiver.

The following list describes many of the basic medical-electronic instruments, and gives the pronunciation when needed.

**Defibrillator** (de-FIB-rill-ay-tor): an instrument which applies an electric shock to the heart through two metal electrodes placed on the surface of the chest. This instrument is employed when the heart is in a dangerous condition known as *ventricular fibrillation*. The muscle fibers of the heart "quiver" rather than contract forcefully. As a result, the heart no longer pumps blood through the body, a condition that is fatal to the patient unless corrected within a few minutes. The electric shock stops the quivering,

often allowing the heart to regain the normal rhythm. Operation of a defibrillator is a favorite activity of the make-believe doctors on TV shows, because it is a true life-and-death matter made dramatic by convulsions of the patient following the shock.

**Echocardiograph** (ECHO-CAR-dee-oh-graph): applies ultrasonic vibrations to the chest and detects the echos returning from the heart. The echos, displayed on a cathode ray tube in radar-like fashion, indicate the position and motion of the heart borders and valves.

**Electrocardiograph** (ee-LEK-tro-CAR-dee-oh-graph): records the electrical activity of the heart, using a long strip of graph paper. The voltage generated by the beating heart is picked up by small, metal electrodes strapped to the arms, legs and chest of the patient. Typically, the peak-to-peak value of the voltage picked up by the electrodes is one millivolt; therefore, the amplifier must discriminate against common-mode hum and noise, while giving high amplification. Because the heartbeat repetition rate is only slightly faster than one per second, the bandwidth required extends from DC to a few-hundred Hertz. One advantage of the restricted bandwidth is that the waveform can be recorded by a pen which writes on a moving strip of paper (see **writer**). The recorded waveform is known as an electrocardiogram, abbreviated either ECG or EKG.

**Electroencephalograph** (ee-LEK-tro-en-SEF-ah-lo-graph): is an instrument which records the electrical activity of the brain. Metal electrodes, placed on the surface of the scalp, pick up the voltage generated by the brain. Some practitioners prefer to use needle electrodes rather than surface electrodes.

The brain waveform is roughly sinusoidal, varying in both frequency and amplitude. Typically, the peak-to-peak voltage is approximately 50 microvolts, and the dominant rhythm—the so-called **alpha** rhythm—has a frequency range of approximately 8 to 12 Hertz.

After amplification in a low-noise, low-frequency, high-gain amplifier, the signal drives a recording pen which writes on a moving strip of paper. The recording is known as an **electroencephalogram**, abbreviated EEG. Typical instruments have 8 or 16 channels (8 or 16 amplifiers and a like number of recording pens) so that waveforms from various areas of the brain can be recorded simultaneously.

**Electromyograph** (ee-LEK-tro-MY-oh-graph): records the electrical activity of muscles. By means of surface electrodes or needles, voltage is picked up from the muscle to be studied. The voltage then is amplified and displayed on a cathode ray tube.

Muscle signals can range in frequency up to several kilohertz. Therefore, they can't be recorded properly by writers of the pen-and-



This is the Burdick Model EK-5A Electrocardiograph, which uses the hot-stylus technique to provide a permanent heartbeat waveform on the tape.

paper types. Of course, a **hardcopy** of the waveform can be obtained by photographing the screen of the scope. Also, the signal can be recorded on magnetic tape for playback and study at a later date.

**Fetal monitor** (FEE-tal monitor): an instrument for monitoring the heart rate of an unborn baby during labor and delivery. As the mother's uterus periodically contracts to expel the fetus (unborn baby), the increased pressure on the fetus may affect its heart rate. This must be monitored closely so that emergency measures can be taken if the fetus is "in trouble."

The fetal monitor records two waveforms on a long strip of chart paper. One waveform represents the fetal heart rate (FHR) and the other shows the uterine contractions (UC). The time relationship between these two waveforms is diagnostically important, and determines whether the process is proceeding normally or whether medical intervention is required.

The fetal heart rate is "sensed" either by surface electrodes or an ultrasonic transducer placed on the mother's abdomen. Pressure inside the uterus is measured by a strain gauge connected to a liquid-filled tube (catheter) inserted into the uterus.

**Non-fade scope:** a medical oscilloscope for displaying the patient's ECG (heart waveform). The conventional oscilloscope used for this purpose uses a cathode ray tube

with a long-persistence phosphor. However, because of the slow sweep—approximately 1 to 10 seconds per sweep—the left side of the trace has already faded by the time the sweep has reached the right side of the screen. As a result, the display on the screen appears as a slowly-moving spot of light rather than a continuous trace. This is often referred to as a "bouncing ball" display.

The **non-fade** oscilloscope, also known as a **refreshed-display** oscilloscope, employs either a loop of magnetic tape or a digital memory to store the ECG waveform. With the waveform available in memory, a faster sweep can be used, and the waveform is displayed as a continuous line rather than a moving spot.

**Pacemaker:** a pulse generator used to stimulate the heart, and thus control the number of beats per minute. Normally, the heartbeat rate is initiated by electrical impulses generated within the heart itself. These impulses travel through conductive pathways within the heart, causing contraction of the heart walls. It is these contractions that pump the blood out of the heart and through the body.

In certain types of heart diseases, the conducting pathways are impaired and the heart is not properly stimulated. In these cases, an artificial pacemaker is used to trigger contractions of the heart.

Under emergency conditions, an external pacemaker is employed. A thin wire inside a flexible tube

(catheter) is threaded through an arm vein into the heart. The pacemaker is connected to the external end of the wire, feeding pulses through the wire into the heart.

If long-term pacing is required, a tiny pacemaker is implanted surgically under the skin, and is connected through thin wires to the heart wall. Battery discharge limits the life of the pacemaker to approximately 24 to 30 months. Then, the pacemaker must be replaced surgically with a new unit.

**Patient monitoring system:** a system of instruments for "electronically watching" the patient, and sounding an alarm when an emergency condition arises.

Each patient is connected to bedside instruments such as heart-rate meter, blood-pressure monitor and oscilloscope. The bedside instruments of each patient are connected by cable to the nurses station. Here, the cables are connected to oscilloscopes, automatic alarms, and a strip-chart recorder. The oscilloscopes display the electrocardiograms of the patients, permitting the nurses to watch all patients for signs of heart irregularities.

The heart-rate instruments can be preset for upper and lower limits. If a patient's heart rate should rise above or fall below these limits, an alarm will sound at the nurses station, a numeral will light up to show which patient is in distress, and that patient's electrocardiogram will be recorded automatically on the strip-chart instrument.





An IVAC electronic thermometer measures a patient's temperature in about 15 seconds, with the exact temperature shown by a digital readout. The probe covers are made of plastic, and a new one is used for each patient. (Courtesy of GTE-Sylvania, Inc.)

**Phonocardiograph:** an instrument for recording the **sounds** of a beating heart. The sounds are picked up by a special microphone that's strapped to the patient's chest. Displacement transducers also might be used to pick up the low frequency vibrations of the chest walls. The signal is amplified and either displayed on an oscilloscope, or recorded on magnetic tape, or both.

The stethoscope—the hollow-tube device with which doctors have traditionally listened to the heart sounds—is a purely-acoustic device of poor sensitivity and sharply-limited frequency response. By contrast, the phonocardiograph detects diagnostically-significant sounds that are either too low in amplitude or too high in frequency to be detected through a stethoscope.

**Pressure monitor:** continuously monitors blood pressure. The instrument is interfaced with the patient through a liquid-filled, flexible tube, which is inserted into either an artery or a vein. Pressure of the blood stream is transmitted through the saline solution inside the catheter to a strain gauge at the other end. Resistance of a strain gauge changes in step with pressure variations, and the circuit translates resistance changes into voltage changes. This voltage signal is amplified and displayed on a meter, which is calibrated in **millimeters of mercury**, or **mm Hg**. That's because mechanical instruments indicate pressure by the height of a column of mercury (chemical symbol Hg) in a glass tube.

Pressure monitors for **arterial** pressure typically are calibrated up to 300 mm Hg, while **venous** monitors read up to 30 mm Hg.

**Writer:** an instrument which traces waveforms on a strip of chart paper. In older instruments, the pen or stylus was a hollow, pointed tube connected to an ink supply. Most modern instruments employ the **thermographic** or "heat writing" technique. In these, a heated stylus writes on plastic-coated paper which turns dark where it is contacted by the hot stylus.

The strip of paper is pulled from a supply roll by a motor-and-gears drive mechanism. As the paper is pulled past the hot stylus, making a dark trace on the paper, the stylus is deflected back and forth across the width of the paper by a galvanometer-type driving mechanism.

The writer, also known as a **strip chart recorder**, can be a separate instrument or it might be a built-in part of a more elaborate instrument such as the electrocardiograph. □



# Reports from the test lab

By Carl Babcoke

*Each report about an item of electronic test equipment is based on examination and operation of the device in the ELECTRONIC SERVICING laboratory. Personal observations about the performance, and details of new and useful features are spotlighted, along with tips about using the equipment for best results.*

## Autoranging Digital Multimeter

- A brief listing of features and specs for the Model 3476A Hewlett-Packard digital multimeter include:
- automatic selection of all ranges (autoranging), with a "hold" button to lock the range when needed;
  - automatic polarity indication;
  - automatic zero circuit (no adjustment required);
  - high-accuracy readings of five automatic ranges for ohms and AC/DC volts, and two automatic ranges for AC/DC current;
  - input resistance is 10 megohms (paralleled by 30 picofarads) for all voltage ranges;
  - resistance and current functions are protected by fuses;
  - 3-1/2 digit red LED readout with continuous lines and automatic decimal point;
  - over-ranging condition shown by

five dashes across the readout; and

- voltage readings are in volts, current readings are in amperes, and resistance readings are in kilohms (thousands of ohms).

## Outside Features

Digital multimeters often are small in size and light of weight, which can cause minor irritations if you try to change ranges or scales and find the instrument sliding around on the bench. With the Model 3476A, the problem is solved (even though pushbuttons are used) by a sloping rim above the buttons. Just grasp the rim with a couple of fingers and punch the required button with a thumb (as shown in Figure 1).

On the right side are three banana jacks (Figure 2) for the test leads. The third jack is used only

for current. With the test leads removed, the panel (with the markings) can be slid to the right, so the two fuses can be popped out, when required for test or replacement.

A heavy-duty 3-wire power cable plugs into the left side, and a wire bail underneath can be adjusted to any of three positions to raise the front of the meter as desired.

Six pushbuttons, located to the right of the readout, select all functions, as explained in Figure 3.

## Autoranging DC Volts

The autoranging operates at all times to select either a higher or lower range as needed. Shift up and shift down does not occur at precisely the same voltage because a small overlap is necessary to prevent "dead" spots. Therefore, **no** voltage within the range of the instrument can cause a missing, false, or misleading reading.

Overrange (excessive reading) of any range or function is indicated by five non-flashing dashes (Figure 4), so it cannot be confused with any reading.

Autopolarity also helps avoid errors of interpretation. Positive numbers have no prefix, but negative readings have a minus sign before the numbers (Figure 5).

It's fascinating to apply a variable DC voltage and watch the display change polarity, decimal points, and number of digits. Although the specs call this a 3-1/2 digit action, there are certain voltages that cause the readout to have **four** digits. Most digital meters of this rating have three digits that can assume any number from 1 through 9, plus a digit at the left that doesn't light, or it indicates a 1. The Model 3476A has four full digits, plus the extra 1, which counts as a half, although most actual readings show only three digits.

Note the progression of readings in Figure 6. Maximum reading of the most-sensitive range is .11 volts. Above that point the meter switches itself to the 1.1-volt range, followed by the 11-volt, 110-volt, and 1100-volt ranges, if the input voltage rises enough. Maximum recommended voltage is 1000 volts DC,



Appearance of the Hewlett-Packard Model 3476A digital multimeter.

and the input resistance is 10 megohms.

The sampling rate is about three times per second; however, the display is steady without flashing or blinking, unless the input voltage changes.

When four numbers were displayed, the digit at the right sometimes had "bobble", which is a change from one number to another (for example, a reading of 10.22 might change occasionally to 10.23). But when three numbers were displayed, I did not notice bobble at any time. (Of course, bobble is natural with digital meters because a count might begin or end in the center of a pulse.) This represents good performance.

Accuracy of DC-voltage measurements typically is .5% or better. There is a slight change of accuracy between ranges. A readout of .0001 is 100 microvolts or .1 millivolts, and is the smallest voltage that can be measured.

### Autoranging AC Volts

AC-voltage operation was very similar to that of DC, including the same ranges. There is no polarity-indication, of course, and the AC converter is average-responding and calibrated in RMS. In other words, the readings are accurate only for sine waves.

Frequency response checked good over the audio band. The response was -1 dB at about 45 KHz and -6 dB at 60 KHz, which was much better than the factory specs. Basic accuracy at low frequencies is said to be 2%, or better.

Factory specs call for AC readings down to 300 microvolts (.0003), while this sample had a minimum reading of .0004 with the test leads shorted together. Input resistance is 10 megohms, so this small amount of hum and noise is satisfactory. Input voltage should not exceed 700-volts RMS or 1100-volts peak, to prevent damage to the meter.

### Autoranging Current Readings

Two current ranges are provided to give 1% accuracy of DC current from 1 milliampere to 1.1 amperes, and approximately 3% accuracy for AC currents from 3 milliamperes to

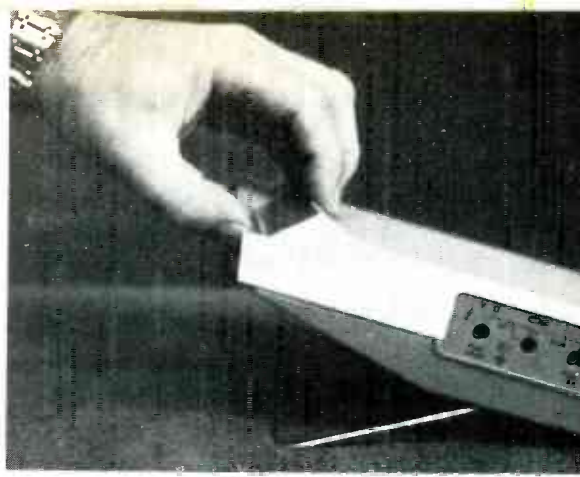

Fig. 1 Depressing the pushbuttons without moving the unit is easy by grasping the curved rim at the top.

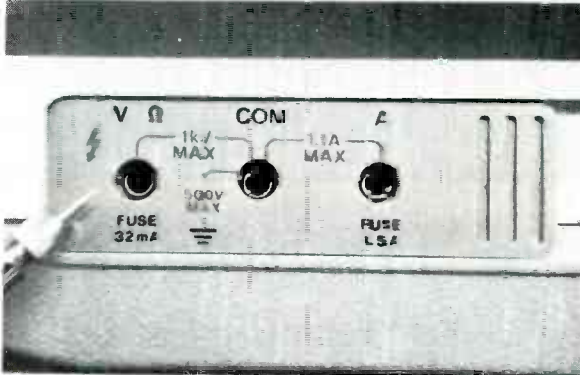

Fig. 2 Only current readings require moving the "hot" test lead. Reversal of the test leads for DC readings is not necessary, because of autopolarity.

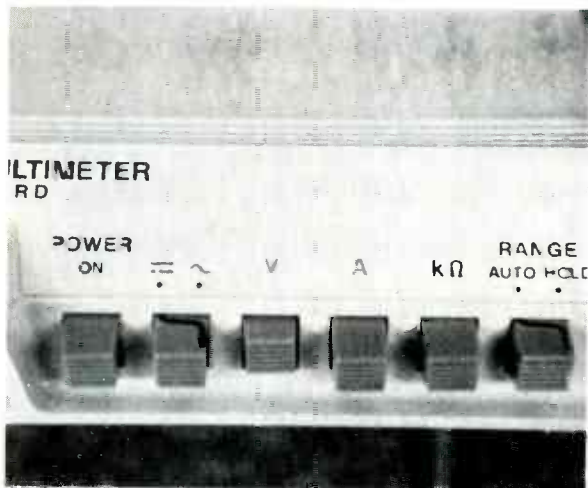

Fig. 3 Button at the left turns power on or off; the second button has a curved line which points to the DC symbol when out, and the sine wave symbol for AC when latched in; pressing any of the next three buttons releases the other, for selecting voltage, current, or resistance measurements; and the last button also has a curved line showing that out gives "auto" operation, and in is to lock or "hold" the range that is in use.

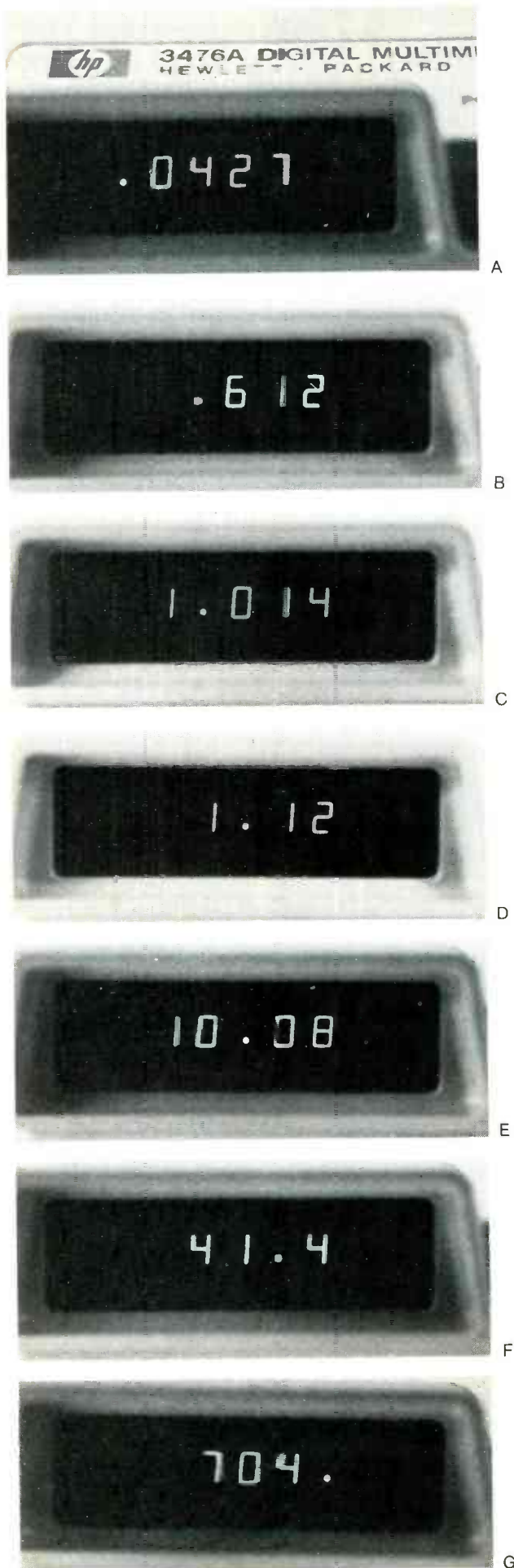

Fig. 4 A series of non-flashing dashes indicates overload or overrange.



Fig. 5 Negative voltages produce a minus sign before the readout; no indication is used for positive voltages or currents.

**Fig. 6** This sequence shows how the autoranging changes the readouts. (A) The zero-to-.11-volt range gives a full four-digit reading; (B) Less than one volt on the 1.1 range provides three digits, which changes to four digits (C) between 1.000 and 1.1 volts; (D) Above the change to 1.1-to-11 volts, the reading has three digits to 9.99, then four (E) above 10.00. (F) Above 11 volts, the meter gives three digits until the change at 110 volts; then (G) three digits to 999 volts, and four digits above.



1.1 amperes. The readout is in amperes.

Input resistance is 1.5 ohms for all measurements of both AC and DC currents, and the frequency response for AC current is the same as that given for AC voltage.

### Autoranging Resistance Readings

All resistance readings are in thousands of ohms. A readout of .001 is 1 ohm, 10.4 is 10.4K ohms, and the top readout of 11000 is 11000K (or 11M) ohms.

Voltage across the test leads with no load was about 3 volts, with the "hot" wire positive and the common wire negative. However, the highest resistance not causing over-ranging produced a voltage between 1 volt and .1 volt, depending on the range.

In fact, for a time I thought this low ohmmeter voltage would prevent forward conduction tests of silicon diodes and transistor junctions. Ohmmeter voltages are very important for testing circuits containing semiconductors, as well as checking out-of-circuit diode junctions, so I always measure the voltages of all ranges.

A chart was made up of the DC voltages across the test prods when measuring various resistances within each ohmmeter range (with the range on hold). Open circuit voltages were about 2.95 volts, but some readings brought the voltage down as low as .002 volts.

The Hewlett-Packard manual deals with the problem of testing diode junction resistance, but the first time through, I read it too fast and missed a point. So, I developed my own method of testing, and was chagrined to find the extra trouble was unnecessary.

Anyway, the manual partially said "the 3476A must be downranged to the lowest ohms range in order to measure semiconductor resistance". Downranging to the lowest resistance range can be done either by shorting together the test leads and pushing the "Hold" button, or switching to current function and then to hold. Unfortunately, I could not read silicon



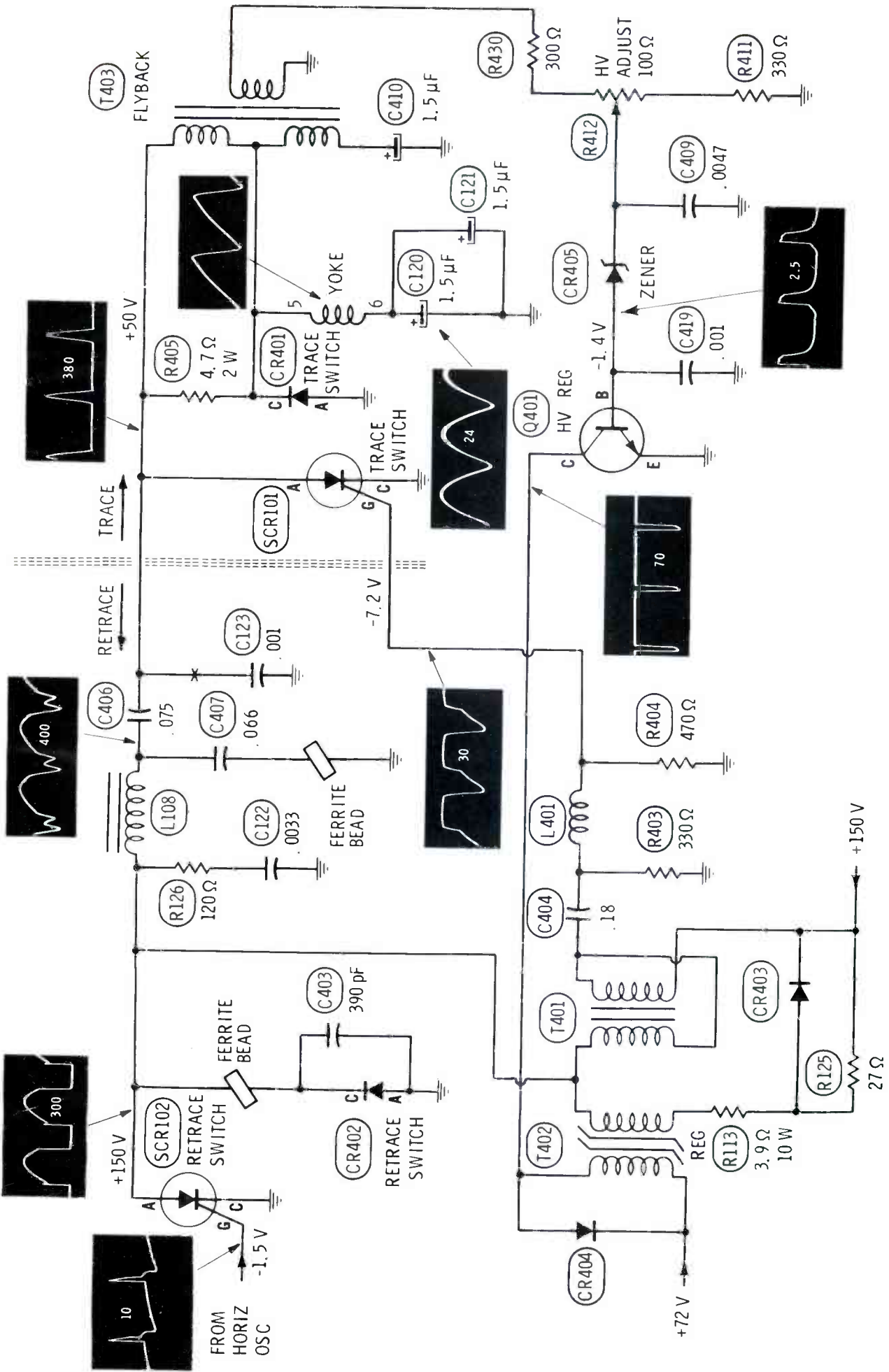

Fig. 9 All components of the RCA CTC58 horizontal-sweep circuit are shown here (except the oscillator), plus enough of the flyback and HV wiring to illustrate HV regulator operation.

an open R405 or a short across it seems to make little difference in the performance.

### Theory of regulation

Last month's explanation of the horizontal sweep included only the yoke current that determines width. The large pulses on the trace side were necessary for ringing, but they served no other useful purpose. In the complete machine, the pulses furnish power to the flyback transformer (T403 in Figure 9). In turn, the flyback supplies various pulses for AGC and other functions, plus pulses used for B-boost, focus, and HV DC voltages. C410 acts as an AC ground for the primary of the flyback.

Because the yoke and the flyback are essentially in parallel, regulating the amplitude of flyback pulses also regulates the width.

The HV ADJUST control (R412) sets the amplitude of the flyback pulses before they reach the zener diode, CR405, which eliminates a constant portion of the pulses that are applied to the base of Q401. An open CR405 kills the regulation, causing excessive HV and out-of-lock horizontal. If CR405 is shorted,

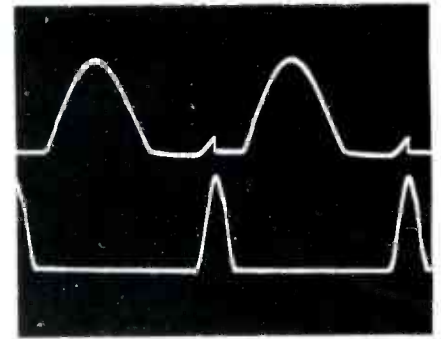
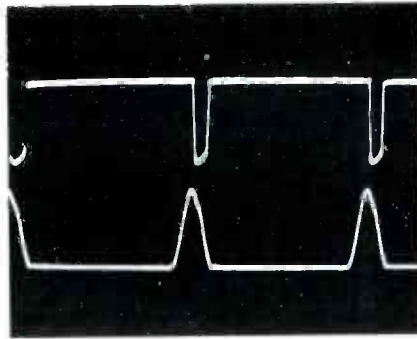

Fig. 10 Top trace of the left picture shows the normal waveform at the collector of Q401, the HV regulator transistor. SCR101 pulses are included (bottom) for a phase comparison. When CR404 is open, the waveform changes to the top trace of the right picture; regulation is lost, causing excessive HV; and the protection circuit forces the horizontal out of lock.

the circuit breaker trips immediately.

Base/emitter rectification of the positive-going pulses at the base of Q401 produces a negative DC voltage there, and the pulses (acting as forward bias) cause strong collector current through T402, the regulator transformer.

Diode CR404 is paralleled across the collector winding of T402. Figure 10 shows the normal collector waveform and the abnormal

waveform when CR404 is open. The reason for including CR404 is a little obscure. Probably it's there to clip the retrace waveform which otherwise would be induced from the other winding. At any rate, if CR404 is either open or shorted, the regulation is eliminated. This causes about 29KV of high voltage, then the overvoltage protection circuit operates to throw the horizontal out of lock.

While we're on the subject of

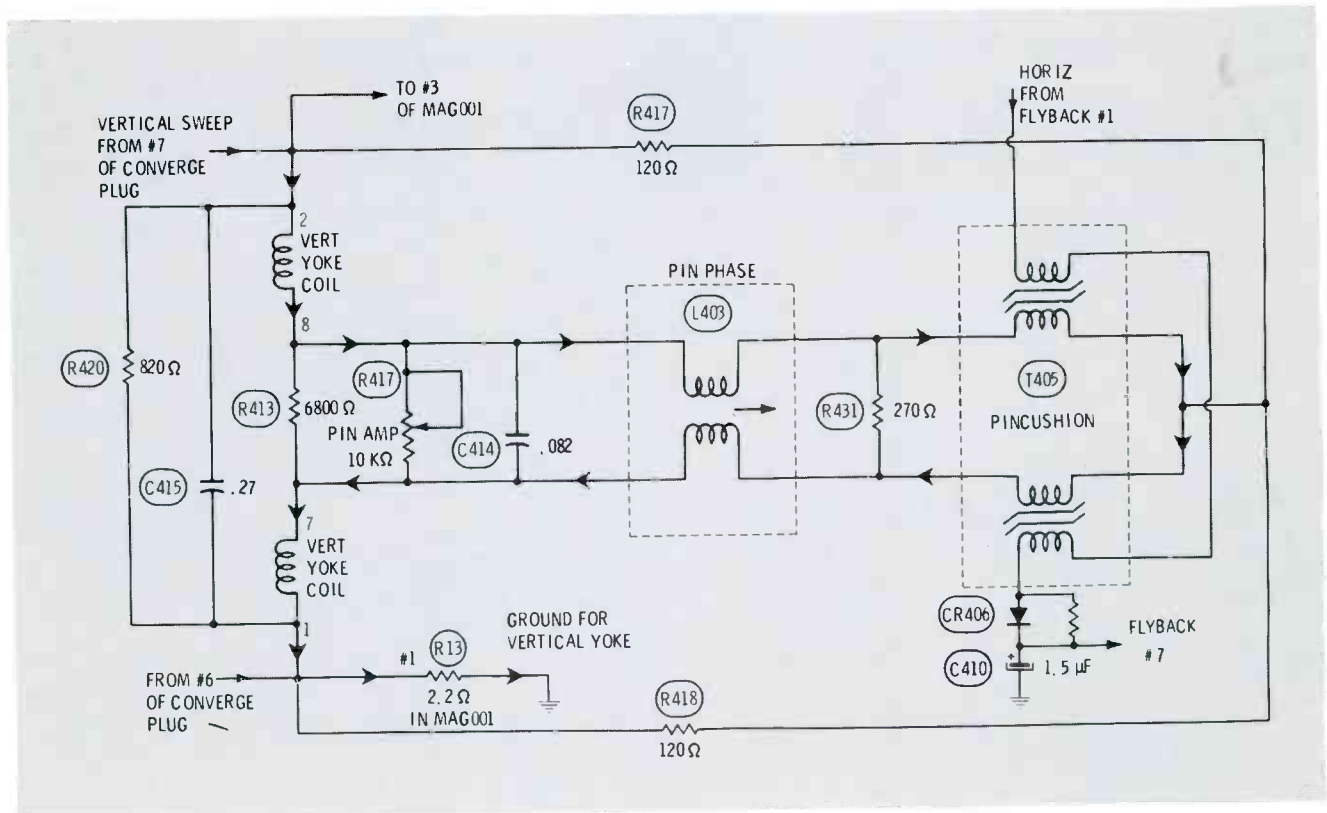

Fig. 11 Both top/bottom and side pincushioning are corrected by this one circuit. Tilt and amplitude are adjustable for top/bottom, but side correction is not variable. Arrows show the path of the vertical yoke current. R417 and R418 are anti-ringing resistors.

forward resistances on the lowest range although germaniums would provide a reading.

Again, I examined the charts showing voltage versus range, and noticed that the range above the lowest (1.1K to 11K) had higher voltages than the ones above and below it. After some experimentation, I connected a 5.6K resistor to the test leads, letting the meter autorange, and pushed in the "Hold" button, locking it to the 1.1K to 11K range. The readings of silicon power supply diodes and transistor B/E and B/C junctions then were about the same as when measured on the X1K range of a VTVM that has a 1.5-volt ohmmeter battery (about 5K typically).

A second reading of the manual disclosed this method:

- Connect the diode (or transistor junction) to the test leads, with the anode (P material) to the hot lead, and the cathode (N material) to the common lead;
- Depress the "A" button (for current), causing the meter to downrange to the lowest range;
- Push the "Hold" button to lock that range;
- Depress the K-ohms button (a shorted junction will read a low resistance);
- Release the "Hold" button, allowing autoranging to the next range; and
- Take the reading. (Overrange or a high reading indicates the junction is open.) Silicons should be around 5K and germaniums about 800 ohms. Push in the "Hold" button, in preparation for the following leakage test.
- To measure the junction leakage, reverse the test leads at the diode or transistor, and release the "Hold" button, allowing the instrument to autorange up to a reading.

I would suggest the meter be used on autoranging for resistance tests in circuits containing semiconductors, to minimize the possibility of diode-type conduction giving false resistance readings. Then when you want to check diode junctions, follow the preceding method of measuring with the next-to-lowest range.



Fig. 7 Some of the screw-in tips for the test prods are shown here.

### Options

Several accessories are available for the H-P 3476A digital meter. The test-lead kit has a red and a black lead and four different pairs of tips that can be screwed into the handles (see Figure 7). These include alligator, phone tips, banana, and needle point types.

An RF probe extends the AC frequency range to 700 MHz, and a soft carrying case has a shoulder strap, which allows the instrument to be operated while it is being carried.

Model 3476A is AC operated only, and sells for \$225. Hewlett-Packard explains their development of "fine-line, tantalum-nitride" resistors as one reason for the moderate price of an autoranging instrument. These resistors are trimmed by laser to .02% tolerance, and exhibit good temperature stability because they all are part of one assembly.

Model 3476B is similar but also operates on nickel-cadmium rechargeable batteries (\$275).

Dimensions are 2.3" high, 6.6" wide, and 8.1" deep, with a weight of 1-9/16 pounds.

### Comments

Operating the Hewlett-Packard Model 3476A digital multimeter was a pleasure. The autoranging feature extends the traditional digital advantages of accuracy and readability. (Most digital meters position the decimal point to prevent errors common with analog

meters of the operator being unsure which range is in use.)

But there is another point. A digital meter locked to the 1000-volt DC range, theoretically can measure down to 1 volt, but the readings become very inaccurate near the bottom of the range. No reading is possible between 1 volt and 2 volts, for example, which could mean an error of nearly 100%. That's why the full tolerance specification of the 3476A reads, for the 1.1 volt and 11-volt ranges: plus or minus (.3% of reading added to .1% of the range). In the 1-volt example, .3% of 1 volt is .003 volts (which is very good), but .1% of the 1000-volt range is 1 volt, making the total tolerance  $\pm 1.003$  volts. This could mean that a 1-volt reading might be less than zero, or it might be 2.003 volts!

This is a strong reason to use the **lowest** voltage scale possible without overranging. (In fairness, the tolerance of a 900-volt reading calculates to be  $\pm 3.7$  volts, which is excellent.) Autoranging automatically selects a range giving high accuracy.

Temperature stability appeared to be very good. A "D" cell produced a reading of 1.56 volts, which did not vary or flicker for the test time of about six hours. At the end, the case was barely warmer than room temperature.

The Hewlett-Packard 3476A digital multimeter proved to be very satisfactory during tests as well as actual servicing operations. □



# SERVICING RCA XL-100

Part 5/By Gill Grieshaber, CET

The first discussions explain how some waveforms were made and the significance of other waveforms and voltages; they are followed by information about high-voltage regulation and pincushion-elimination circuits, and finally the waveform analysis of many sweep component failures.



## Stretching Scope Waveforms

The voltages at the output of C406 caused by trace currents flowing through CR401 and SCR101 ordinarily are not seen on a scope. During trace time, one or the other of these devices is conducting, thus making the voltage drop nearly zero (less than a volt across each). During retrace, nearly 400-volts PP of HV pulses are there. Problem: **how do you view just 2 volts out of 400?**

First, I tried to use excessive scope gain, driving the top of the HV pulses off screen. This almost worked, because it showed the base line had a waveform, but making the signal large enough to photograph properly overloaded the scope amplifiers, causing distortion of the waveform.

After some experimentation, I wired a 10K resistor and a damper diode as a shunt clipper that removed the positive pulses, leaving

little except the baseline (Figure 1).

Even then the waveform was somewhat different according to where the leads were attached (because of voltage drops across the chassis and common wires). This accounts for the small differences compared to the same waveform in Step 5.

The small sine waves that appear on some of the scope waveforms are a minor mystery. They show only on current waveforms, or voltage waveforms made small by clipping. Their amplitude and position change according to the brightness of the picture, so it seems definite that they come from the receiver. The same kind of sine waves appear also when the current of a horizontal-output tube is being viewed.

## More Explanations

Some condensation was necessary to prevent confusion. Now we'll try to clarify a few points.

### SCR102 gate drive

Precise turn-on time is required by the gate of SCR102 (by contrast, the turn-off time of SCR101 is critical). Also, there can be no false pulses or double triggering; they would upset the timing of the various steps.

Figure 2 gives the SCR102 gate waveform with the zero-voltage line added by DC scope action. Notice that the positive-going portion (the only part affecting the SCR) is narrow and clean. The gate has little typical diode effect; therefore, there's only a small negative voltage, and the zero line is not far from where it would be without the SCR gate.

### Peculiar anode voltages

The waveform at the anode of SCR102 is there only about two-thirds of the time. Yet when it's

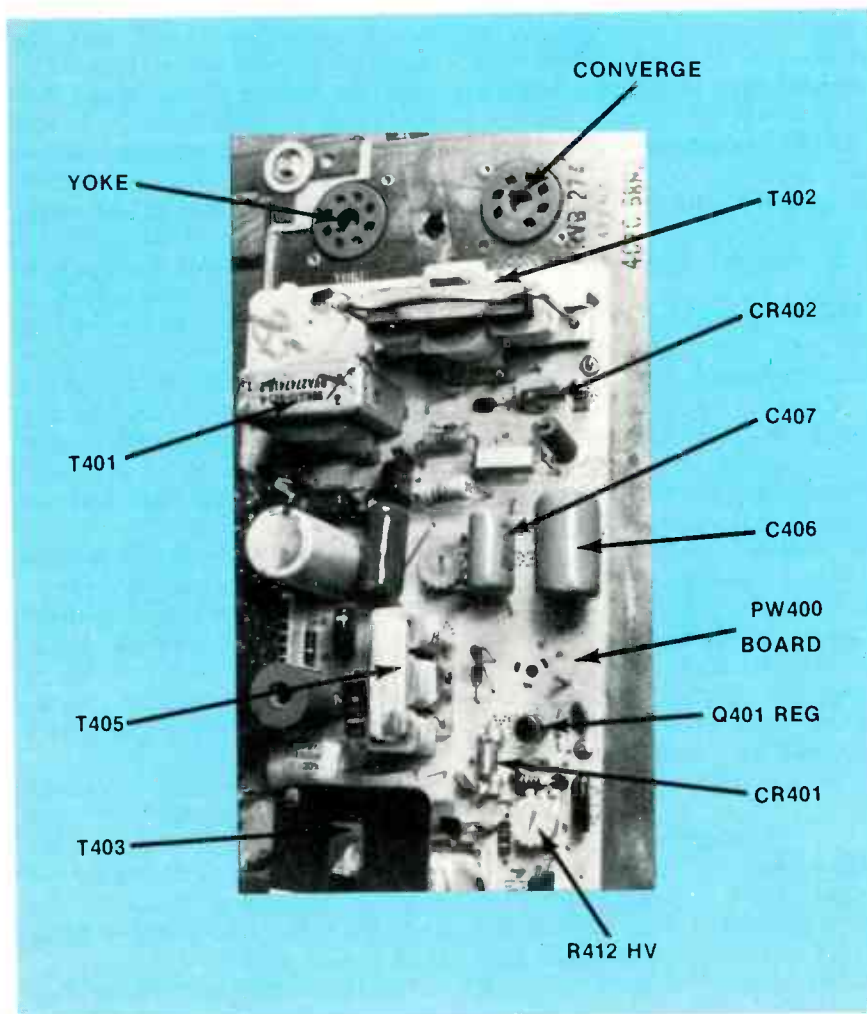

Arrows point to some of the horizontal-sweep and regulator components of the RCA CTC58 chassis.

tested by a DC voltmeter, the reading is almost identical with the supply voltage. Have you ever wondered how this could be? Other signals that are missing part of the time have a reduced reading. The answer is in the waveform of Figure 3. B+ supply voltage of this particular set was +151 volts DC, which appeared at the anode of SCR102 when CR402 stopped conducting. But the voltage did not maintain the same level, because ringing of the regulator circuit swung it up and then down in a portion of a half-cycle of sine wave. Just before conduction of SCR102 reduced the voltage nearly to zero, the instantaneous voltage was about +200 volts (this voltage changes to fulfill the regulator requirements). Ringing has acted as a DC transformer! Anyway, the curving top part of the waveform for a longer time equals the bottom part that's there for a shorter time. By chance the average DC voltage equals the input supply voltage.

#### SCR101 gate drive

Gate signal for SCR101 trace SCR comes initially from an extra winding of the transformer that replenishes the power to the retrace section. However, the signal must be shaped by a two-stage filter, as shown by Figure 4. In operation, the gate has a positive signal for most of the trace time, but the anode doesn't go positive until the middle of the trace. Both gate and anode remain positive (and the SCR conducting) until time T3, when both go negative, forcing a sudden cessation of current.

The zero line added to the waveform of Figure 5 explains why the gate shuts off so suddenly. The zero voltage is very near the top of the waveform, so only a small amplitude decrease moves the gate down into the zero-voltage area. Then SCR101 stops conduction as soon as the anode reaches zero, also.

#### DC without DC input

One of the quickie tests of the sweep system is to measure the DC voltages at the anodes of SCR102 and SCR101. Both are accessible, and the cases connect to the anodes. SCR102 has supply voltage, as explained before. Surprisingly,

SCR101 measures about +50 volts, yet there is no DC path into the trace section. What is the source of this voltage?

If the pulses of Figure 6 were supplied through a capacitor, the average line across near the base line would represent zero voltage, and the effect of the positive waveform above the line would equal the part below the line. Therefore, the DC voltage would be zero. That's not the case here.

The pulses are formed by C406 in reference to ground. In other words, the base line is at zero volts, and the average line is about +48 volts from zero (this can be mea-

sured on a scope or a DC meter; both agree).

By the way, those HV pulses are not the true waveform across C406, but just from one end to ground. The top waveform of Figure 7 is the waveshape from the L108 end to ground, the center one is the SCR101 end of C406, and the trace at bottom is the waveform across C406. This last waveform was obtained by adding the traces inside the scope, but a single-trace pattern with the scope connected across C406 (floating) verified its accuracy. (Floating a scope that far above ground is not recommended because of the shock hazard.)

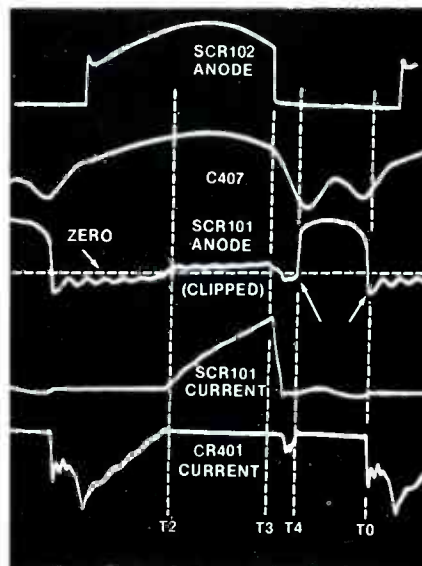

Fig. 1 The cathode of CR401 must be about -1 volt for it to conduct from time T0 to T2, and the anode of SCR101 must be about +1 so it can conduct from T2 to T3. Therefore, the baseline between huge pulses at the anode of SCR101 cannot be zero. A clipper circuit inserted between anode of SCR101 and the scope removed most of the pulse amplitude (center waveform), revealing the small DC voltages that trigger on and off the SCR and trace diode. At T3, the negative-going signal through C406 begins to pinch off the anode current of SCR101. When this current stops (between T3 and T4) the voltage overshoots to become negative, triggering a small current through CR401. At T0, the negative pulse that starts conduction of CR401 is visible.

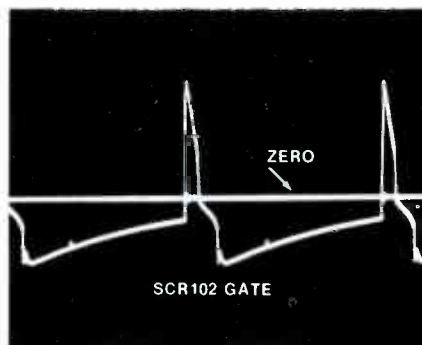

Fig. 2 Adding the zero-voltage line to the gate-drive waveform of SCR102 shows that the only positive parts of the waveform are the narrow pulses which give precise triggering. The line also shows why the negative DC voltage at the gate is so small.

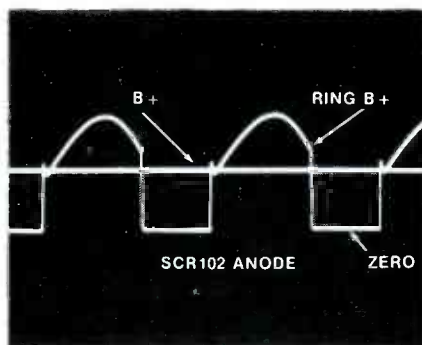
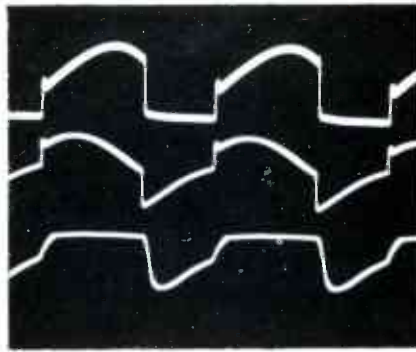
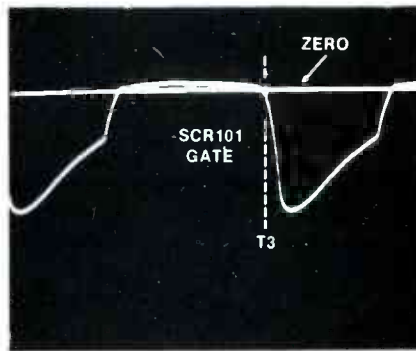

Fig. 3 The average voltage at the anode of SCR102 is almost identical to the input B+ supply voltage, at normal brightness. Regulation is accomplished by varying the resonant frequency of the regulator components. A higher frequency swings the ringing voltage up to its maximum more quickly, thus allowing it to drop to a lower voltage (which reduces HV and width) before SCR102 conducts. The arrow at RING B+ indicates the DC voltage at the anode of SCR102 when it fires.

**Fig. 4** These waveforms show the steps of filtering the gate signal of SCR101. Top trace is the waveshape from T401 to the input of C404; the center waveshape is found at the junction of C404, R403, and L401; and the bottom trace shows the gate signal at the output of L401 and R404. C404 and R403 form a high-pass filter, while L401 and R404 comprise a low pass filter.



**Fig. 5** The DC-coupled dual-trace scope adds a zero-voltage line to the SCR101 gate signal, showing how little the waveform must go down to make the gate negative. When both the anode and gate of SCR101 are zero volts, conduction is zero.



**Fig. 6** This waveform explains how a DC meter can read +48 to +50 volts DC at the anode of SCR101, and yet there is no path for DC to reach the anode. That's because the baseline is zero volts; therefore, the average voltage of the pulses is positive.

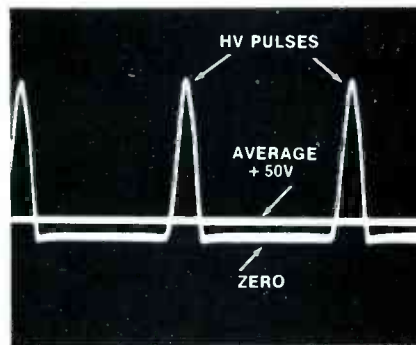

**Fig. 7** It's difficult to show the waveform across C406. One way is to display the input waveform (top trace) and add it inside the scope to the output waveform (center trace) to produce the total waveform (trace at the bottom).

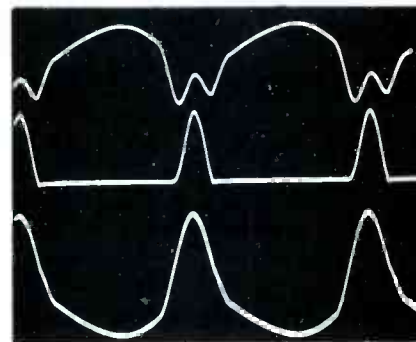

**Fig. 8** Normal extremes of the regulator ringing are shown by this double exposure. At the top, low line voltage and a dark raster cause the regulator to reduce the ringing voltage that's present when SCR102 fires. The bottom trace shows the ringing from high line voltage and a bright raster. More sweep power is needed, so the voltage is higher at the time SCR102 conducts. Frequency of the ringing at top is about 9300 Hz, and at bottom it is about 8000 Hz.

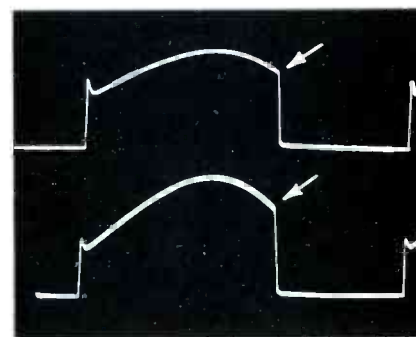

## High-Voltage Regulation

It seems appropriate for a horizontal-sweep circuit that operates by controlled ringing to have high-voltage regulation by ringing, also. And this one does. Any increase of picture-tube current must cause a like increase of power to the sweep circuit, else the high voltage will decrease. In addition, any minor change of line voltage should be offset by a change of DC voltage to the SCRs.

Ringing first increases the B+ voltage at the anode of SCR102, and then decreases it in the shape of half a sine wave. When SCR102 starts to conduct, the voltage from ringing (stored in C406 and C407) should be exactly the amount needed for proper sweep and high voltage.

Specifically, regulation is accomplished by varying the frequency of ringing in the replenishing part of the circuit. A higher frequency of ringing allows the sine wave to reach the positive peak more rapidly; and then to decrease to a lower voltage before SCR102 fires. At the other extreme, a lower ringing frequency does not permit the voltage to fall so far before it's used by the SCR. Therefore, a **high ringing frequency reduces the high voltage, while a low ringing frequency increases the high voltage** (Figure 8). Measurements with a triggered scope gave a frequency of 9300 Hz, when the screen was black, and about 8000 Hz with a bright raster.

Figure 9 shows the complete horizontal-sweep circuit, less only the pincushion components and some HV and flyback wiring.

Two minor features need mentioning. The C120 mentioned before is not 3 microfarad as stated, but actually there are two 1.5 microfarad capacitors in parallel (C120 and C121) to serve as ringing capacitor during the trace time. If one of the two opens, the picture becomes wider, but with compression of linearity at the right edge.

The anode of SCR101 and the cathode of CR401 are not connected together directly, but to each end of a 1-turn winding of the flyback, with a damping resistor (R405) in parallel. Probably this provides better linearity; however



diodes, an open or shorted CR403 increases the width about a quarter inch on the right and raises the HV about 500 volts. None of the major waveforms seem to be affected. However, it's likely that a permanent short would cause T402 to overheat, and an open might overload R125 so it would fail eventually.

B+ to replenish the power used by the sweep circuit reaches the retrace section through a winding of T401, which is paralleled by a winding of T402, the saturable-reactor regulator transformer. Saturable-reactor transformers are specially wound and balanced so very little AC from one winding is induced in the other; however, the saturation of one winding changes the inductance of the other. In other words, direct current from Q401 through the "primary" of T402 changes the inductance of the "secondary" winding that helps supply B+ to the retrace stage.

During conduction time either SCR101 or CR401 grounds C406, so the resonant circuit for regulator ringing consists of: the inductance of T402 and T401 in parallel; L108 (has little effect now); and the parallel capacitance of C406 and C407. Only T402 has a variable value.

When excessive amplitude of flyback pulses causes Q401 to draw more collector current, the inductance of the regulator tuned circuit (T401 and T402 in parallel) is decreased. This raises the ringing frequency so the voltage at the anode of SCR102 decreases to a lower value before SCR102 conducts. The lower "input" voltage reduces the width, the high voltage, and the pulses at Q401.

### Pincushion Correction

Both horizontal and vertical pincushion distortions are corrected by the circuit of Figure 11. Arrows mark the path of the vertical sweep signal from the convergence plug to ground. Horizontal pulses from the pincushion transformer (T405) are tuned by L403 and C414, and adjusted in amplitude by R417. While viewing a crosshatch pattern, turn R417 fully clockwise, adjust L403 for an upward bulge of the top horizontal line near the center of the raster, then reduce the setting of R417 to make this line straight.

If L403 is incorrectly adjusted, the right side of the raster will be taller than the left side, or vice versa.

Side correction of pincushion distortion also is provided, but without any adjustments. The vertical yoke

current through T405 changes the inductance of T405 to cause a variable load on the flyback.

An open in L403 or T405 can cause a trapezoidal raster, similar to that obtained when one vertical yoke coil is open.

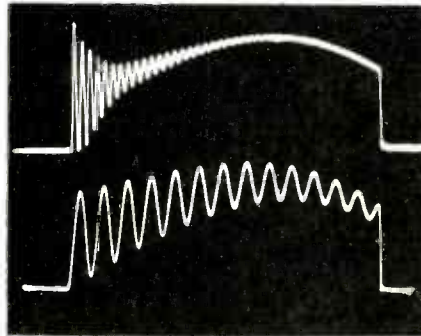

Fig. 12 An open C122 or R126 produces a high-frequency damped wave train at the anode of SCR102 (top waveform). A different kind of ringing occurs when R126 is shorted, or has a low-resistance value.

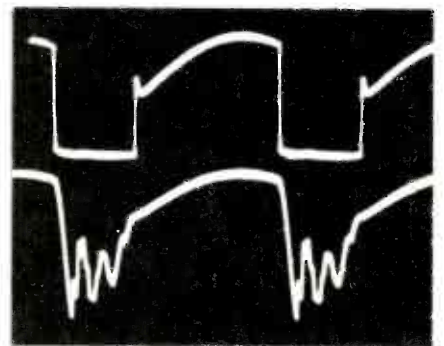
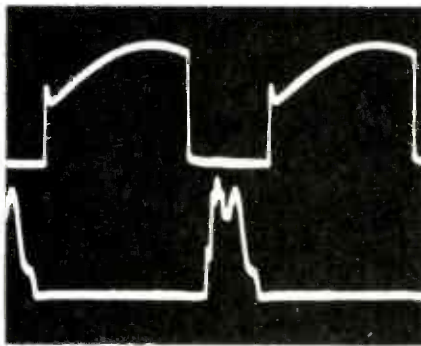

Fig. 13 Distinctive symptoms and waveforms result from an open C407. HV regulation is poor, and the pulse waveforms at SCR101 anode have wrinkles (lower trace of the picture at left). Also, the negative peak of the signal at the input of C406 is distorted (lower trace of the right picture).

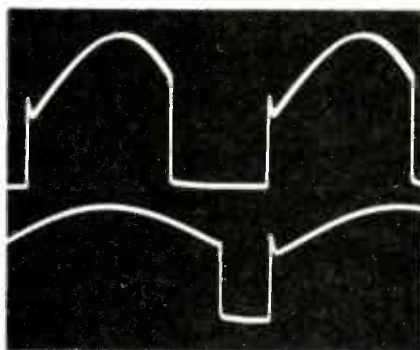

Fig. 14 A loss of signal on the trace side of the circuit can be determined by the waveform at the anode of retrace SCR102. The top waveform is normal, while a shorted SCR101 or CR401 produces the bottom waveform. An open C406 causes nearly the same waveshape. Notice the increase of trace time, the shortened retrace base line, and the lower oscillator frequency.

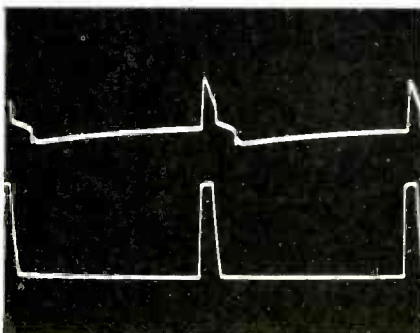

Fig. 15 If there are no AC waveforms at the anodes of either SCR102 or SCR101 and the lower waveform is at the gate of SCR102, it's a cinch the gate/cathode junction of SCR102 is open. Gate current in normal operation changes the pulses, as shown by the trace at top.

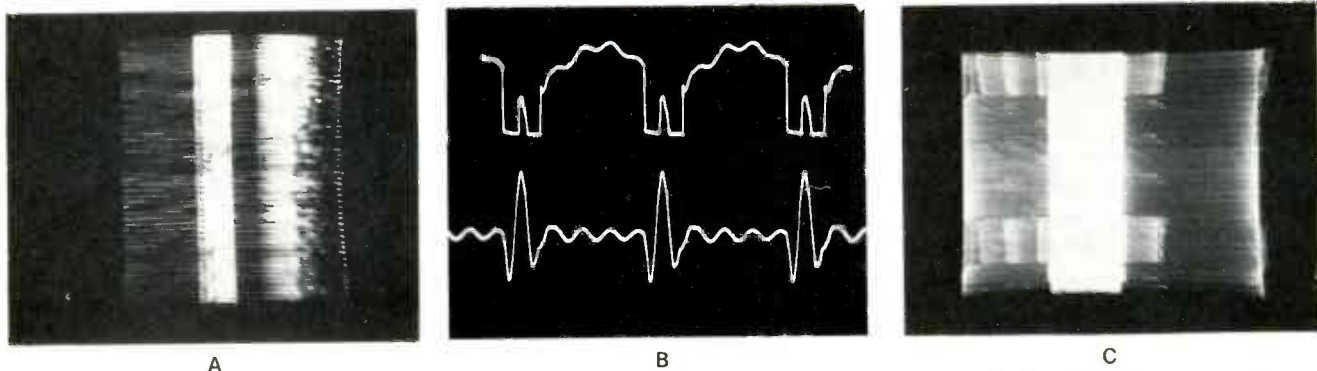

Fig. 16 A narrow, unstable raster with wide foldover near the center is typical of opens in CR401, SCR101, or the drive to SCR101. (A) This dim raster was produced by an open CR401. (B) An open CR401 gave these waveforms: anode of SCR102 (top); and (bottom) the anode of SCR101. (C) A flashing, too-bright raster, and occasional arcs from HV or focus resulted from an open SCR101. When L401 was open, the symptoms were similar, but the foldover moved less.

### Waveforms And Parts Defects

Several components that appear in Figure 9 were not explained before. For example, C403 and C123 each parallel an SCR to minimize radiation of switching transients which might appear as vertical lines in the picture when the signal from the station was weak. The ferrite beads give the effect of an inductance (RF coil), but do not have the drawback of self-resonance. C404 and R403 form a high-pass filter; and L401 and R404 form a low-pass filter. Together these filters shape the desired signal to drive SCR101, as shown in Figure 4.

R126 and C122 damp out one kind of unwanted ringing from the retrace circuit. Short-duration high-frequency ringing (top trace of

Figure 12) is produced by an open C122 or R126. A shorted R126 causes a ringing of longer duration, as shown by the bottom trace of Figure 12.

### Poor regulation

Symptoms of poor regulation (excessive HV with a dim picture and slightly-low HV with normal brightness) might be caused by an open C407. Check the waveforms at C407 and the anode of SCR101 for clues (Figure 13). I know of no other defect producing that kind of a jagged waveform.

### Dead trace section

One unique feature of the SCR-sweep circuit is that the retrace circuit will have a nearly-normal waveform at the anode of SCR102

even when the trace section has **no** signal. The retrace circuit merely idles, without harm. The waveforms of Figure 14 give two examples. An open C406 coupling capacitor or a short on the trace side (for instance, from the anode of SCR101 to ground, or if CR401 shorts) produce similar waveforms.

### Open SCR102

An SCR102 with an open gate/cathode junction is easy to identify by the changed gate waveform (Figure 15).

### Foldover and whistling

A narrow raster with bright, wide foldover in the center, along with an audio tone from the sweep circuit, are the general symptoms of an open SCR101, or an open CR401 (Figure 16). A defective component in the gate filter for SCR101 also will cause the same symptoms.

### Foldover at left

Figure 17 shows the trace and retrace waveforms and the screen when a CR402 retrace diode was open. Operation for a short time without CR402 didn't seem to overload anything, but after three or four minutes R126 started to smoke. The amplitude on the retrace side was more than 1000 volts PP!

### Next Month

Detailed troubleshooting methods and other tips covering the horizontal and HV sections of the RCA CTC58 will be the subject next month. □

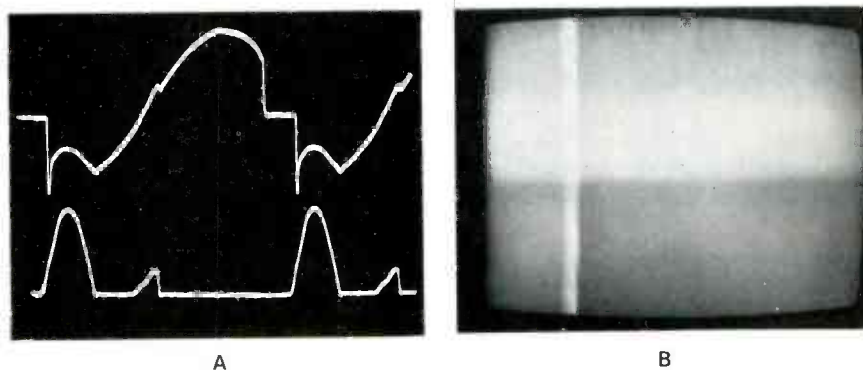

Fig. 17 When CR402 (retrace diode) was open, both the picture and raster were almost normal, except for the white foldover about 4" from the left edge. However, the signal at the anode of SCR102 was about 1000 volts PP, and R126 started to smoke after a few minutes. (A) Waveform at the anode of SCR102 is at the top, and the bottom trace shows the waveform at the anode of SCR101. Notice the extra bump on the baseline. (B) With a blank raster, the foldover appeared as a white vertical line. (The dark lower half of the raster was caused by the camera shutter.)



# OHMWARD BOUND!

by Edmund A. Braun

Start going around with this Pinwheel Puzzle and have fun! It's based on Electronics. The last letter of each word is the first letter of the next word. Each correct answer is worth 4 points; a perfect score is 132. It should be easy to get a high rating, except perhaps for someone who thinks "dipole" is a resident of Warsaw who passed away, or that "odograph" refers to the signature of a movie star! So take a deep breath and GO!

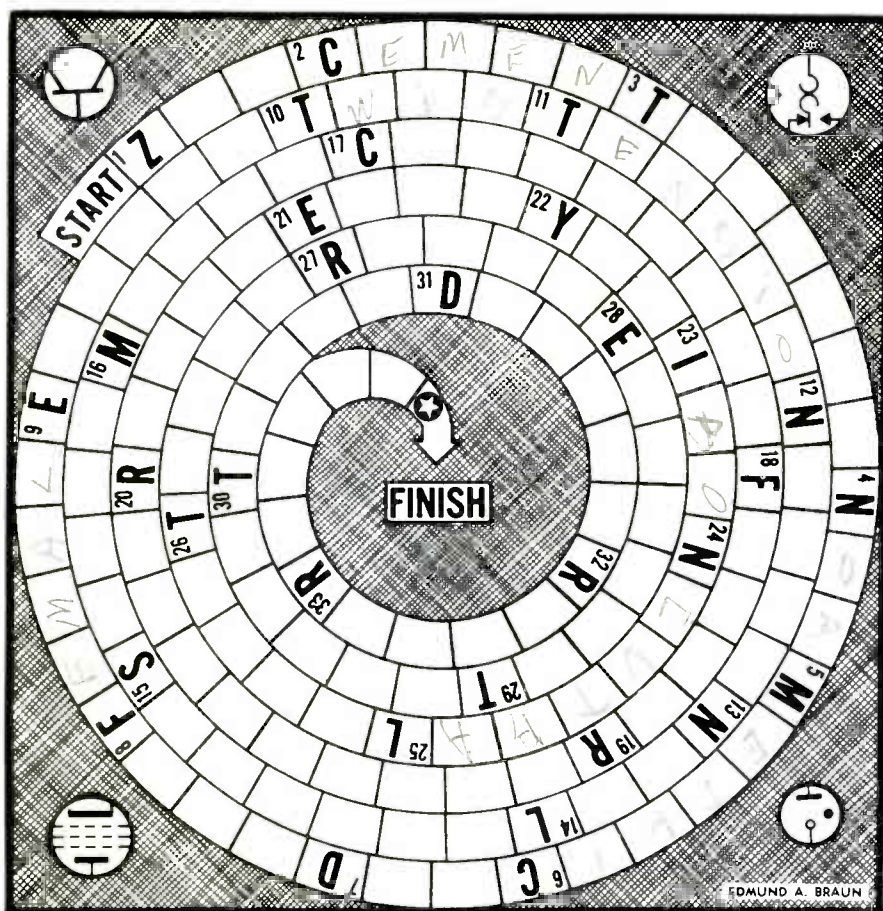

- 1 A bluish-white crystalline metallic element.
- 2 Any substance used for making bodies adhere to each other.
- 3 A positive or negative ion which has been emitted from a heated body.

- 4 The mean or average; a customary condition or degree.
- 5 Decimal system of weights and measures.
- 6 The tiny piece when a hole is punched in a card or paper tape.
- 7 Unit of elastance; equals the reciprocal of capacitance.

- 8 Recessed portion of a device into which another part fits.
- 9 Draw out; make empty of gas or air.
- 10 Cause to rotate or turn.
- 11 Condition of strain which tends to stretch.
- 12 In mksa system, unit of force that will impart an acceleration of 1 mps to a mass of 1 km.
- 13 Balanced condition which results in zero output from a device or system.
- 14 The intensity of sound.
- 15 Thin metal vane which has been perforated with an appropriate wave pattern.
- 16 Light-sensitive surface of an iconoscope or other TV camera tube.
- 17 Antenna having radiating elements shaped like a good luck symbol.
- 18 Heavy wire conductor supplying electricity to other wire conductors.
- 19 A four sided plane figure with four right angles.
- 20 Excursion above or below the average peak amplitude.
- 21 A sturdy resin-type adhesive.
- 22 Type of directional antenna.
- 23 A common metallic element; symbol Fe.
- 24 Neither positive nor negative.
- 25 Diagram indicating the positions of parts on a chassis or panel.
- 26 Thread of contrasting color woven into insulation to identify a wire.
- 27 Radio or TV program originating outside the studio.
- 28 An electric analog of a permanent magnet.
- 29 Straight line which touches the circumference of a circle at one point.
- 30 A ring or ring-like.
- 31 Unit of optical measurement which expresses refractive power of a lens or prism.
- 32 One type of insulation for wire.
- 33 A placement in a certain rank or class.

Now let your fingers do the walking to the solution on Page 53.



# test equipment report

These features supplied by the manufacturers are listed at no-charge to them as a service to our readers. If you want factory bulletins, circle the corresponding number on the Reply Card and mail it to us.

## Transistor Tester

The improved Model 520B semiconductor tester from the **B&K-Precision** division of Dynascan features a choice of Hi-drive or Lo-drive for better accuracy of readings.

It is not necessary to connect the transistor to any specific test leads; rotation of the "TEST" switch supplies all six possible connections. LEDs marked "PNP" and "NPN" show the polarity, and that the transistor is good, when they light. An internal speaker sounds an audible tone, also, when the transistor is non-defective. If a polarity LED lights on two positions of the "TEST" switch, the Lo-drive should be selected. Neither LED lights when the transistor is defective.

The "IDENTIFY-LEAKAGE" switch has a spring to return it to the center position. It should be rotated to the "IDENTIFY" position to determine whether the transistor is silicon or germanium. The color of LED which lights shows the color of meter scale to be used for the leakage test.



Hi-power drive makes in-circuit tests possible when the shunt resistance is as low as 10 ohms, and the shunt capacitance is as high as 15 microfarads.

Model 520B semiconductor tester is AC powered, and has a list price of \$160.

For More Details Circle (25) on Reply Card

## 3-1/2-Digit Multimeter

**Systron-Donner** has introduced a new 3-1/2-digit multimeter. Model 7003 has 5 complete functions, 26 ranges, 2000 count capacity, large 0.4-inch 7-segment LED display, and features a circuit-breaker current overload protection circuit. It is said to be the first such instrument to have true RMS AC-measurement capability. An adjustable stand enables the unit to be tilted up or down for convenient bench use.



Model 7003 sells for \$295.

For More Details Circle (26) on Reply Card

## Audio Test Center

**Leader Instruments** has introduced 12 test instruments that are suitable for an "Audio Test Center." There is a choice of two recurrent-sweep scopes: Model LBO-310A for general-purpose use; and Model LBO-552, which provides two traces (with one large difference from most scopes—the traces are side-by-side).

The Model LAV-190 is a 3-in-1 audio analyzer, functioning as an audio generator, attenuator, and AC millivoltmeter. A companion instrument is the LDM-170 distortion meter, which also measures signal levels and signal-to-noise ratio.

Leader also offers 4 generators: Model LSG-231 multiplex or FM-stereo generator with pilot signal; low-distortion audio generator Model LAG-125 which also has square waves and audio-burst signals; the LAG-120 which has sine and square waves from 10 Hz to 1 MHz; and Model LAG-26 for testing transient response and distortion.

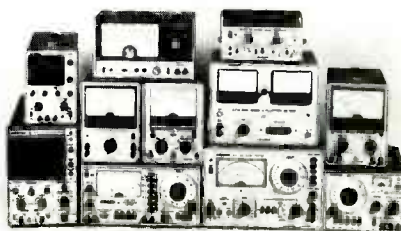

These are the three voltmeters: Model LMV-89 measures AC voltages from 100 microvolts to 300 volts in two channels; a similar range is covered by Model LMV-87A, with higher input impedance of the single channel, and stabilized power supply; and Model LEM-75, a battery-AC FET multimeter for testing DC and AC volts and current, plus ohms. This meter has an optional probe for measuring ambient temperature.

The LFM-36A solid-state Wow-And-Flutter meter also simultaneously measures drift of tape recorder mechanisms.

For More Details Circle (27) on Reply Card

## VOM Series

The new **Weston 660** series of VOM's feature "drop-proofed" protection. They are warranted in writing to work even after accidentally being dropped five feet. The smallest precision multimeter on the market, the 660 series incorporates such



features as: diode-protected meter movement; special calibrated scales for dB measurement; pluggable circuit-board assemblies; and external fuse replacement.

For More Details Circle (28) on Reply Card

## High-Accuracy Digital Multimeter

DC voltage readings with an accuracy of .01%  $\pm 1$  digit, and a readout with 4-1/2 digits are two specifications of the Model 4600 digital multimeter manufactured by **Dana Laboratories**. All ranges can be selected by an "up" or a "down" button, or the instrument can select the best range by full autoranging, and auto-

polarity. The yellow LED digits are .43" high.

Ranges of AC and DC volts are from 10 microvolts to 1000 volts, ohms readings are from 10 milliohms to 20 megohms, and AC/DC current ranges are from 10 nanoamperes to 2 amperes. Input resistance on the two lowest voltages is 10,000 megohms. Dana's combination of a filter and an integrator is said to give 80 dB rejection of normal-mode noise.



Model 4600 sells for \$549. Option 82 is a HV probe allowing voltage measurements up to 5 KV (\$40); Option 83 is a 50 KV probe for \$45; and Option 84 is a \$60 RF probe for measurements up to 200 MHz.

For More Details Circle (29) on Reply Card

### Test Clip

The "Dip Clip", Pomona Electronics' Model 3916 for attachment of test probes to 15 or 16 lead DIPS, has been revised. The latest version is wider and longer than its predecessor and uses polycarbonate thermoplastic for insulation. Spring-loaded wiping

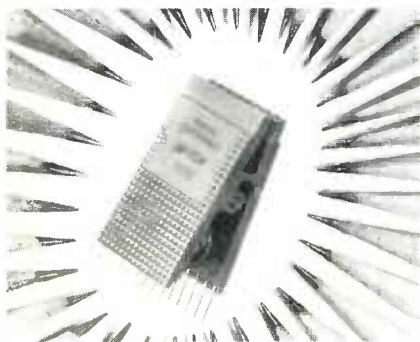

action of contact pins gives good electrical connection; a special contact design gives positive positioning, preventing accidental shorting of adjacent leads.

For More Details Circle (30) on Reply Card

### Pocket-Sized Digital Multimeter

Sencore offers Model DVM-35, a portable battery-operated digital multimeter. Some of the features include: 3-digit readout, with 1% accuracy of DC voltages; four AC and DC voltage ranges covering 1 volt to 1000 volts full scale; four AC and DC current ranges from 1 milliampere to 1 ampere full scale; three "low" power ohms and three "high" power ohms ranges, together covering from 100 ohms to 10 megohms full scale; and an input resistance of 15 megohms for all voltage ranges.

A "times two" button on the probe doubles all voltage readings, thus changing the input resistance to 30 megohms and the maximum voltage reading to 2000 volts. Also, on the probe is the "touch on" button, which eliminates all battery drain between measurements.



Portable power is obtained from AA-size batteries, or AC operation is possible by use of a Model PA202 adapter/charger. Probe HP200 allows high voltage measurements up to 50 kilovolts. Model DVM-35 is said to be "drop-proof" and "burn-out-proof", and sells for \$124.

For More Details Circle (31) on Reply Card

Give  
till it  
helps.

The American  
Red Cross.  
The Good  
Neighbor.

A Public Service of This Magazine & The Advertising Council

There is only  
one

# 2-WAY

## RADIO HOME STUDY COURSE

exclusively devoted

to professional FM radio equipment

We don't know how many TV repairman or other people there are in electronics who would like to move up to professional FM two-way radio.

Nor do we know how many servicemen and installers there are already in the field who want to expand and upgrade their knowledge.

But we do know how many home study schools cater exclusively to both these groups.

## ONE!

Please send me more information.

Name \_\_\_\_\_

Address \_\_\_\_\_

Code \_\_\_\_\_

- I am a former MTI student.
- I am presently in the military.
- I am a veteran.

Formerly

### MOTOROLA TRAINING INSTITUTE

Summerdale, PA 17093  
(717) 732-3636

For More Details Circle (13) on Reply Card



## Checklist of Books for Electronic Technicians!

- Master Hdbk. of 1001 Pract. Electr. Circ's. 602 p., 1250 il. \$9.95
- T-shooting with the Dual-Trace Scope. 224 p., 252 il. \$5.95
- Microprocessor/Microprogramming Hdbk/c. 294 p., 226 il. \$6.95
- Impedance. 196 p., 90 il. \$5.95
- Op Amp Circuit Design & Applications. 280 p., 239 il. \$6.95
- Build-It Book of Miniature Test/Meas. Instr. 238 p., 151 il. \$4.95
- Digital Logic: Processors/Memories/Interfaces. 294 p. \$6.95
- Switching Regulators & Power Supplies. 252 p., 128 il. \$6.95
- TV Schematics: How to Read Between the Lines. 252 p. \$5.95
- Microelectronics. 266 p., 228 il. \$5.95
- Electronic Music Circuit Guidebook. 224 p., 180 il. \$6.95
- MOSFET Circuits Guidebook. 196 p., 104 il. \$4.95
- Electronic Conversions, Symbols & Formulas. 224 p. \$4.95
- Zenith Color TV Schematic/Svcng Manual, vol. 4. 196 p. \$5.95
- CB Radio Schematic/Service Manual, vol. 1. 200 p. \$5.95
- CB Radio Schematic/Service Manual, vol. 2. 200 p. \$5.95
- CB Radio Schematic/Service Manual, vol. 3. 200 p. \$5.95
- Aviation Electronics Handbook. 406 p., 227 il. \$8.95
- Digital/Logic Electronics Handbook. 308 p., 226 il. \$6.95
- 21 Simple Transistor Radios You Can Build. 140 p., 122 il. \$3.95
- CB Radio Operator's Guide. 256 p., 139 il. \$5.95
- Central Htg. & Air Condng. Repair Guide. 320 p., 285 il. \$6.95
- RCA Color TV Schematic/Service Manual, vol. 5. 196 p. \$5.95
- Practical CB Radio Troubleshooting/Repair. 210 p., 108 il. \$5.95
- Advanced Applic's. for Pocket Calculators. 304 p., 275 il. \$5.95
- Small-Screen TV Servicing Manual. 240 p., 367 il. \$6.95
- Transistor Theory for Technicians & Engineers. 224 p. \$5.95
- TV Troubleshooter's Handbook—3rd Ed. 448 p., 300 #. \$4.95
- Tower's International Transistor Selector. 140 p., 7 x 10". \$4.95
- Color TV Case Histories Illustrated. 238 p., 219 il. \$5.95
- The Home Appliance Clinic. 195 p., 61 il. \$4.95
- The Complete FM-2 Way Radio Handbook. 294 p., 111 il. \$6.95
- Effective T-shooting With EVM & Scope. 238 p., 185 il. \$5.95
- RF & Digital Test Equipment You Can Build. 252 p., 217 il. \$5.95
- Basic Digital Electronics. 210 p., 117 il. \$4.95
- Color TV Trouble Factbook—2nd Edition. 348 p. \$4.95
- Servicing Cassette Cartridge Tape Players. 294 p., 196 il. \$6.95
- Small Appliance Repair Guide—Vol. 2. 210 p., 119 il. \$4.95
- Electronic Measurements Simplified. 240 p., 217 il. \$4.95
- CET License Handbook. 276 p., 244 il. \$5.95
- 10-Minute Test Techniques for PC Serv. 216 p., 114 il. \$4.95
- Auto Stereo Service & Installation. 252 p., 245 il. \$5.95
- Logical Color TV Troubleshooting. 240 p., 151 il. \$5.95
- Cassette Tape Recorders—How They Work—Care/Repair. \$4.95
- Pictorial Guide to CB Radio Installation & Repair. 256 p. \$5.95
- TV Bench Servicing Techniques. 228 p., 177. \$4.95
- How To T-shoot & Repair Electronic Test Equip. 252 p. \$6.95
- Modern Communications Switching Sys. 276 p., 171 il. \$17.95
- Understanding & Using the VOM & EVM. 192 p., 187. \$4.95
- Electrical Wiring/Lighting For Home/Office. 204 p., 155 il. \$4.95
- Understanding & Using the Oscilloscope. 272 p., 170 il. \$4.95
- FM Stereo/Quad Receiver Svcng Manual. 192 p., 130 il. \$4.95
- MATV Systems Handbook. 176 p., 91 il. \$4.95
- T-shooting Solid-State Wave Generating/Shaping Circ. \$4.95
- 2nd Class FCC Encyclopedia. 602 p., 445 il. \$7.95
- Pictorial Guide to Color TV Cir. Troubles. 256 p., 262 il. \$4.95
- Marine Electronics Handbook. 192 p., 106 il. \$4.95
- Installing TV & FM Antennas. 168 p., 158 il. \$3.95
- Simplified TV Trouble Diagnosis. 320 p., 292 il. \$5.95
- Pictorial Guide to Tape Recorder Repairs. 256 p., 320 il. \$4.95
- Introduction to Medical Electronics. 272 p., 126 il. \$6.95
- Troubleshooting Solid-State Amplifiers. 256 p., 95 il. \$4.95
- How to Solve Solid-State Circuit Troubles. 304 p., 161 il. \$5.95
- T-shooting Solid-State Elec. Power Supplies. 192 p. \$4.95
- How to Interpret TV Waveforms. 256 p., 250 il. \$4.95
- Kwik-Fix TV Service Manual. 384 p. \$5.95
- How to Repair Musical Instrument Amps. 288 p., 250 il. \$5.95
- Solid-State Circuit T-shooting Guide. 224 p., 150 il. \$4.95
- Installing/Serv. Elec. Protective Systems. 252 p., 160 il. \$4.95
- Using Elec. Testers for Auto Tune-Up. 252 p., 226 il. \$4.95
- All-in-One TV Alignment Handbook. 304 p., 145 il. \$6.95
- 199 Color TV Troubles & Solutions. 224 p., over 180 il. \$4.95
- 199 Electronic Test & Alignment Tech. 224 p., 130 il. \$4.95
- Digital Electronics: Principles & Practice. 288 p., 191 il. \$5.95
- Industrial Electrs.: Principles & Practice. 416 p., 380 il. \$8.95
- Commercial FCC License Handbook. 444 p., 150 il. \$5.95
- Citizens Band Radio Service Manual. 192 p., 36 il. \$5.95
- Modern Radio Repair Techniques. 260 p., 36 il. \$4.95
- How to Use Color TV Test Instruments. 256 p., 230 il. \$4.95
- Modern Radar—Theory, Operation, & Maint. 480 p. \$7.95
- Popular Tube-Transistor Substitution Guide. 256 p. \$3.95
- 199 TV Tough-Dog Problems Solved. 252 p., 199 il. \$5.95
- Major Appliance Repair Guide. 288 p., illustrated. \$5.95
- Computer Technician's Handbook. 480 p., over 400 il. \$8.95
- Vectorscopes-Oscilloscopes/Sweep-Marker Gen. 256 p. \$4.95
- Servicing Modern Hi-Fi Stereo Systems. 248 p., 24 il. \$4.95
- Pulse & Switching Circuits. 256 p., 184 il. \$5.95
- How to Repair Home/Auto Air Conditioners. 206 p. \$4.95
- Home-Call TV Repair Guide. 144 p. \$3.95
- Small Appliance Repair Guide—Vol. 1. 224 p., 100 il. \$4.95
- Installing/Serv. Home Audio Systems. 256 p., 150 il. \$5.95

### NO RISK COUPON—MAIL ENTIRE AD

TAB BOOKS, P. O. Box 40 Blue Ridge Summit, Pa. 17214

Please send me the books checked above.

I enclose \$\_\_\_\_\_ send postpaid.

Please invoice on 10-day FREE trial.  Send C.O.D.

Name \_\_\_\_\_ Phone \_\_\_\_\_

Company \_\_\_\_\_

Address \_\_\_\_\_

City \_\_\_\_\_ State \_\_\_\_\_ Zip \_\_\_\_\_

Foreign add 10%. Pa. add 6% sales tax. ES-36

For More Details Circle (14) on Reply Card

## audio systems report

These features supplied by the manufacturers are listed at no-charge to them as a service to our readers. If you want factory bulletins, circle the corresponding number on the Reply Card and mail it to us.

### Sound Camera

Bell & Howell/Mamiya Company has introduced a low-light Super-8 sound camera which features exposure variation of plus or minus one F/stop for front and backlighting situations; pushbutton fade-in and fade-out control; and a red cue light which alerts subjects when the camera is in operation.



Model 1235 Filmasonic™ XL Super 8 magnetic-sound camera is compact and lightweight. The unit retails for \$389.95, and also features an ear-phone sound monitor and full-time pushbutton power zoom.

For More Details Circle (32) on Reply Card

### Electronic Crossover

Designed for use with 2- or 3-way speaker systems, the Shure SR106 electronic crossover is a rack-mountable, unity-gain, line-level, balanced input and output selectable-frequency dividing network.

The device separates the output of an audio console or mixer-preamplifier into two frequency bands for distribution to separate power amplifiers and low- and high-frequency speaker systems.

The SR106 unit provides switch-selected crossover frequencies of 500 Hz, 800 Hz, and 2,600 Hz. Net price of the device is \$93.00.

For More Details Circle (33) on Reply Card

### Wall-Mount CB Extension Speaker

A large wall-mount speaker designed for Citizens Band use, the CB-600V provides maximum voice clarity, and has a separate volume control.



The unit from Argos Sound has a 6-watt capacity and 8-ohms impedance.

For More Details Circle (34) on Reply Card

### One + One Intercom

The One + One Ektacom intercom offered by Fisher Berkeley Corporation has a master unit with one slave station. The remote station can call the master, but does not require switching at that end after the conversation begins. The amplifier is



solid-state equipped, and does not require a location near an AC outlet because a separate UL-listed power supply is used. A model with heavy-duty switches is available.

For More Details Circle (35) on Reply Card

### Tape-Head Demagnetizer

An economy-model magnetic tape-head demagnetizer has been introduced by Robins Industries.

The unit should be used about every 20 hours to demagnetize the

(Continued on page 48)



# productreport

These features supplied by the manufacturers are listed at no-charge to them as a service to our readers. If you want factory bulletins, circle the corresponding number on the Reply Card and mail it to us.

## FM Weather Band Converter

A tiny new FM weather-band converter for autos, boats, trucks, and campers has been introduced by **Audiovox Corp.** Model WB-70 converts any FM radio to receive official U.S. weather bureau 24-hour weather forecasts. The FM radio should be tuned to 90 MHz. The converter also amplifies weak FM radio signals.



Quickly installed, it mounts anywhere under the dash of a vehicle. Instructions are included for single and dual mounting.

Suggested list price is \$24.95.

For More Details Circle (36) on Reply Card

## Base/Mobile CB Transceiver

Designed for either mobile or base-station operation, the **Pearce-Simpson Bearcat 23-C** has: dual power supply, one meter to read receiving signal strength or relative transmitted power, and another for modulation or VSWR measurements; crystals for 23



CB channels; a desk microphone with press-to-talk switch; modulation and on-the-air lights, a digital clock that rings an alarm or turns on the CB at a selected time; automatic noise limiter, and RF noise blanker with manual override; jacks for phones, external speaker, or public address; and mike-gain and tone controls.

For More Details Circle (37) on Reply Card

## Aluminum Solder

Alu-Sol 45D soft solder from **Multi-core** solves problems of soldering many aluminum alloys that previously were hard to wet. It has silver, tin, and lead, with a special flux in four cores near the surface. Alu-Sol 45D is compatible with standard tin-lead solders, and is said to give excellent results with tin plate, copper, brass, nickel, and nickel-silver materials. Also, good results are claimed with steel, stainless-steel, and zinc alloys. A soldering temperature of 660° F. is recommended.

For More Details Circle (38) on Reply Card

## Cable-Installation Tools

D'versiBit tool system reduces the time required for in-wall cable installations. The tools can be used for installation of coaxial cable and electrical cable within all types of building walls. A standard quarter-inch drill is used to drive the tools.

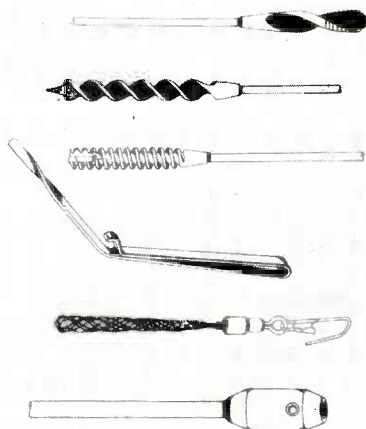

The various items that make up the system include: a half-inch auger bit with a 54-inch flexible shaft for easy starting of a clean entrance hole; a half-inch carbide-tipped masonry bit with a 54-inch flexible shaft for drilling cement blocks and plaster; and a half-inch combination bit with a 54-inch flexible shaft for greater durability and general-purpose use. Also

(Continued on page 46)

# DIGITAL PERFORMANCE YOU CAN RELY ON.



The Hickok Model 334 DMM is a rugged, non-temperamental, hardworking tool that's easy to use and easy on your eyes. Hickok has established a unique reputation in digital electronics during the past 10 years. The Model 334 is another example of our engineering expertise — an economical lab quality instrument with exceptional durability and accuracy.

- Easy reading, green fluorescent display
- 3½ digit — auto polarity
- 26 ranges including 200 mV AC & DC ranges
- Fast response — 2.5 readings/sec

Basic Accuracies (% of reading)
DC Volts; ±0.2% (±0.5% on 200V, 1200V ranges)
AC Volts; ±0.5% (±2.0% on 200 mV, 2V ranges)
OHMS; ±0.5%
DC Current; ±1.5%
AC Current; ±2.0%

Ask to see the Model 334 at your Hickok distributor. It's a no compromise DMM at a price you can afford.

**\$229<sup>00</sup>**

# HICKOK

the value innovator

INSTRUMENTATION & CONTROLS DIVISION  
THE HICKOK ELECTRICAL INSTRUMENT CO.  
10514 Dupont Avenue • Cleveland, Ohio 44108  
(216) 541-8060 • TWX: 810-421-8286

For More Details Circle (15) on Reply Card

available is a special alignment tool to guide and hold steady the D'versiBit flexible shafts; a line-recovery pulling-grip attachment for drawing RG-59 and RG-6 coax cable through the drilled holes; and a 54-inch extension attachment.

The D'versiBit tool system is marketed by **Blonder-Tongue Laboratories**.

For More Details Circle (39) on Reply Card

### Projects Handbook

Nine state-of-the-art projects are included in the Semiconductor Projects Handbook published by **GC Electronics, Calectro Division**.

The Handbook features an assortment of general-interest projects varying from a simple decade counter to a complex waveform generator, including a crystal timebase, SCA decoder, dual power supply, C-MOS digital thermometer, and others. Each project describes the theory of operation, as well as providing printed circuit board layouts, detailed drawings for suggested enclosures and intended applications. The price is \$1.00.

For More Details Circle (40) on Reply Card

### FM Signal Booster

"Stereo One" is an automobile FM signal booster designed to minimize signal fade and flutter associated with weak-signal FM reception. It can be used with any auto AM/FM radio without any adverse effect to normal AM/FM reception. The circuit more than triples the received signal in the "on" position to clarify FM reception in fringe areas.



"Stereo One" is a two-piece unit consisting of an amplifier section that mounts close to the auto radio, and an on-off control switch with an LED indicator light that self-mounts on the dash.

All necessary mounting hardware and instructions are supplied with the "Stereo One," which is manufactured by the **Finney Company**.

For More Details Circle (41) on Reply Card

### Wire Stripper

A tool with plastic blades to strip the insulation from wires? Yes, if the plastic is Stilan, which was developed originally for the aerospace program. The **Alpha "Plastic-Blade Stripper"** has cutting edges that are harder than insulation, and softer than copper. As you squeeze the handles, the broad Stilan blades close on the insulation; next, the holding blocks grasp the wire. Further movement causes the blades and the blocks to move apart, with the blades cutting through the insulation, deforming or bending around the copper wire, and removing the insulation from the wire. Releasing the handles allows the wire to be removed.

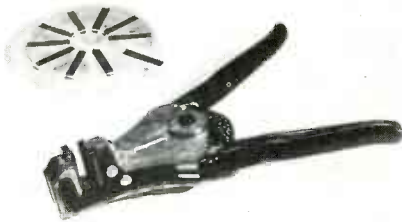

No adjustment is necessary (or possible) for different sizes of wire from AWG-12 to AWG-28. Several wires can be stripped at the same time, and the wire can be placed anywhere along the blades.

The manufacturer estimates up to 50,000 strips with simple hook-up wire; less with harder insulation (it's not recommended for Teflon and Kynar). However, new blades can be pushed in place, without tools, in a method similar to that used with injector razor blades.

The Alpha Plastic-Blade Stripper lists at \$39.95, with three sets of blades.

For More Details Circle (42) on Reply Card

### Silicon Focus Rectifiers

Silicon rectifiers rated at 8000 peak reverse voltage and 5 milliamperes

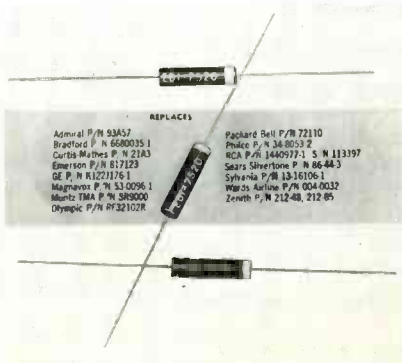

are direct replacements for most selenium focus rectifiers in color TV receivers. Silicon types change less from heat and age than seleniums do. **Electronic Devices** also has many kinds of "Solid Tube" solid-state replacements for vacuum tubes.

For More Details Circle (43) on Reply Card

### Noise Cancelling Microphone

Astatic's "Trucker II" noise-cancelling microphone eliminates most cab noises. In one test, the truck's air horns were blown while the cab windows were rolled down, and no additional noise came over through "Trucker II."

It has a transistor amplifier and an adjustable output level over a range of approximately 40dB. Compatible



with virtually any outfit, "Trucker II" converts easily from "electronic" to "relay" operation.

For More Details Circle (44) on Reply Card

### Solid-State Guide

The 1976 edition of the **RCA Solid State Replacement Guide** now is available. The book—SPG-202S—cross-references more than 112,000 domestic and foreign solid-state devices which can be replaced with RCA SK-Series types.

An additional feature of the Guide is an index of RCA SK-Series semiconductors and accessories. Also included are significant characteristic and application information, line drawings of dimensional outlines and terminal arrangements, and a listing of mounting hardware.

The 160-page Guide has a suggested price of \$1.00.

For More Details Circle (45) on Reply Card



### Auto-Noise Filters

A self-service merchandiser from **Sprague Electric** has Q-Line filters packaged with installation instructions. Four of the filters are feed-through types for mobile applications and are rated at 20, 40, 60, and 100 amperes for minimizing noise from

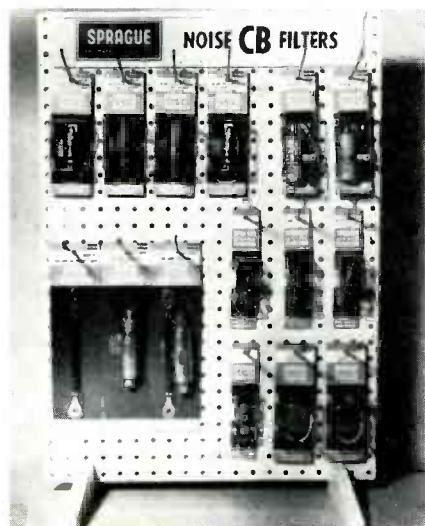

alternators, generators, ignition coils, voltage regulators, and other auto devices. A DC electrolytic battery-power filter is for AM/FM radios and tape decks, and the sixth unit is an AC power-line filter for fixed base-station applications.

For More Details Circle (46) on Reply Card

### Video Modulator

Video signals from a TV camera are applied to a VCM-4924 modulator (manufactured by **Blonder-Tongue**), and the modulated-carrier output RF connected to a MATV system in home or apartment. The camera picture can be tuned-in by TV receivers connected to the system, by the usual way.

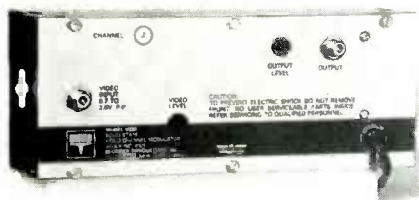

The modulator has a vestigial-sideband filter, has good response suitable for either monochrome or color, and can be used on any standard VHF channel. Price is \$99 without crystal control, or \$136 with crystal control.

For More Details Circle (47) on Reply Card

### CB Transceiver

The **E. F. Johnson Company** has announced a new low-cost CB transceiver, the Messenger 121A. It has many of the features found in Johnson's other CB radio models; included are built-in automatic speech compression on transmit, and automatic noise limiting on receive.

The radio also features maximum FCC-permitted power and push-button selection of up to five CB channels (crystals for the five channels desired are selected and purchased separately by the user). It is supplied complete with microphone, mounting bracket, DC power cord and



built-in loudspeaker. An accessory power supply is available to convert the radio to 110-volt AC base station operation.

The Messenger 121A is covered by Johnson's one-year parts and labor warranty. Suggested retail price is \$99.95. □

For More Details Circle (48) on Reply Card

# The Good Neighbor is you.



Red Cross.

## Belong.

A Public Service of This Magazine & The Advertising Council 

**Some stores sell test equipment at discount prices.**

**At Fordham we discount their discount prices.**

B&K, EICO, RCA, SENCORE  
FLUKE, HICKOK, LEADER  
and SIMPSON

Complete line of tubes,  
tools and electronic supplies

**FREE CATALOG**  
**FORDHAM**

RADIO SUPPLY CO., INC.  
558 Morris Ave., Bronx, N.Y. 10451  
Tel: (212) 585-0330

For More Details Circle (16) on Reply Card

# need belts?



**Standard and special belts and tires** ready for immediate shipment — fit over 3,000 new and obsolete makes of tape recorders, projectors, dictating machines, video recorders, and turntables. Simplified cross reference system makes ordering easy with **one day service** on most items. Drive tires, wheels, phono idlers also listed. Call or write for **free catalog**. DEALER INQUIRIES INVITED.

**PROJECTOR-RECORDER BELT CORP.**

319 Whitewater St., Whitewater, WI 53190 — (414) 473-2151

For More Details Circle (17) on Reply Card



(Continued from page 44)

tape heads in reel-to-reel, cassette, or cartridge tape recorders and players. Magnetized heads cause noise, hiss, high-frequency loss, and harmonic distortion.

The demagnetizer consists of a line-operated coil with a metal core that extends out of the plastic housing to form a tip. This tip is plastic-covered so it will not damage tape heads. The plastic case is flame-retarding and impact-resistant.



Model R25013 lists at \$8.50, Model R25015 at \$11.

For More Details Circle (49) on Reply Card

### Trumpet Driver

Atlas Sound has a third high-power, mid-range compression driver in its 4000 Custom Sound series.

Model 4030 driver produces 122 dB of sound at 30 watts RMS, within a frequency range of 500 Hz to 7000 Hz.

The 4030 is suitable for use with any 1-3/8"-18 female-thread sectoral, reflex or multi-cellular horn having a 500 Hz cut-off, or as a component of full-range speaker systems.



The driver incorporates a self-aligning, field-replaceable, 2-3/4"-diameter diaphragm/voice-coil with a nominal impedance of 16 ohms. Coded screw-terminals facilitate proper phasing of amplifier-wiring and multi-speakers.

For More Details Circle (50) on Reply Card

### Phonograph Needle

The new UNATET N1776 phonograph needle from Astatic replaces

hundreds of Tetrad type needles, thus reducing stock requirements. It's available with either diamond or sapphire tips.

For More Details Circle (51) on Reply Card

### Deck Tester

Aspen has introduced a "Deck Tester", a simplified way of evaluating all 8-track cartridge players.

Recorded test and voice instructions are simple and clear. A tape speed test can be timed over a six-minute period, or the correct speed can be determined immediately by comparing Middle A of a musical instrument with the test tone. Also included is a right and left speaker test, and a speaker-rattle test. The speakers are electrically thrown in and out of phase so the listener can easily hear the difference.

Wow and flutter, head alignment, worn head and cross-talk problems can be detected.

The Deck Tester lists for \$6.98.

For More Details Circle (52) on Reply Card

### Speaker System

Radio Shack has available a moderately-priced theatre-type speaker system, the "Realistic Mach One".



The speaker features a 15-inch acoustic-suspension woofer with brass voice coil, 4-cell midrange horn, and a high-compliance horn tweeter. Response is given as 20-25,000 Hz, and the Mach One is said to be able to handle 100-watt musical peaks.

Midrange and tweeter level controls can be adjusted to suit the acoustics of any room, and there is a special L-C crossover network. A removable grille allows custom installation.

The "Realistic Mach One" is priced at \$199.50.

For More Details Circle (53) on Reply Card

### Car Stereo

Model JS-8120 is an AM/FM/MPX 8-track in-dash car stereo by Jet Sounds.



It features a 4-3/4" short chassis, a slide bar for easy AM-to-FM switching, local-distance switch, and dial-in-door. The control shafts adjust to 160 mm for full-size domestic cars. With the side extension, the unit will fit into virtually all domestic and imported cars.

Additional features on the JS-8120 include an on/off switch, balance, volume, tone, and manual-tuning controls as well as stereo indicator light and illuminated track indicators.

Suggested retail price of the Model JS-8120 is \$89.95.

For More Details Circle (54) on Reply Card

### Automatic Pager

An electronic instrument that automatically links telephones through paging computers to personal pagers has been introduced by Gimix.

The Gimix "Auto Page" fits under an office telephone and works with any answering machine or answering service and paging system. It can be pre-set to page on every message, or only on messages of certain lengths—emergencies, for example, in which callers are instructed to keep talking for at least 20 seconds to activate the



pager system. If the paging service lines are busy, the "Auto Page" will

(Continued on page 50)

# bookreview

## Fundamentals of Electronic Devices

**Author:** David A. Bell  
**Publisher:** Reston Publishing Company, Inc.,  
 P.O. Box 547, Reston, Virginia 22090  
**Size:** 467 pages  
**Price:** \$15.95 hardbound

Bell's book covers many important electronic devices in general use today, and gives the reader an understanding of the characteristics, parameters, circuit applications, and limitations of each device. The author shows how to design a circuit, estimate circuit gains and impedance, and analyze practical transistor circuits by h-parameters. A logical division of chapters covers vacuum tubes, the pentagrid converter, the modern CRT, zener diodes, UST's, SCR's, and IC's, as well as tunnel diodes, thermistors, and liquid-crystal cells. Many examples are included to introduce the reader to applications of the device under study. A glossary of important terms and a set of review questions are provided at the end of each chapter.

## Closed-Circuit Television Handbook, Third Edition

**Author:** Leon A. Wortman  
**Publisher:** Howard W. Sams & Co., Inc., 4300  
 West 62nd Street, Indianapolis, Indiana 46268  
**Size:** 288 pages, book number 20197  
**Price:** \$7.95 paperback

Guiding the technician through the basic concepts of closed-circuit television (CCTV) to the equipment requirements for an expanding system, this updated edition covers video-tape cassette and cartridge recorders, plus hard-to-find information on lighting and optics. Cameras, monitors, lenses, wiring, microwave relays, servicing, accessories, and CCTV applications are explained in the text with the use of photographs, schematics, tables, and drawings.

**Contents:** What Is Closed-Circuit TV?; Cameras; Monitors; Expanding the System; Video Recording Techniques; Closed-Circuit TV in Education; Closed-Circuit TV in Commerce and Industry; Closed-Circuit TV in Research, Medicine, and Military and Public Service; Lenses, Lighting, and Wiring; Microwave Relays; Circuits and Service.

# photofact<sup>TM</sup>bulletin

<b>BROADMOOR</b> 2412BW .....	1549-1
<b>GENERAL ELECTRIC</b> Chassis 12XB, 15XB .....	1561-1
<b>HITACHI</b> I-28, I-48 .....	1557-1
<b>J C PENNEY</b> 4901UA, 4902UA, 4906UA, 4914UA, 4915UA, 4916UA .....	1548-1
<b>MGA</b> CS-130C .....	1551-2
<b>PANASONIC</b> Chassis ETA-10A .....	1561-2
<b>SANYO</b> Chassis SF-74000, SF-76000 .....	1563-1
<b>SEARS</b> 562.50172500, 562.50730500 .....	1563-2
<b>SONY</b> KV-1520R (Ch. SCC-25C-B) .....	1557-2

## The Money Generator



**GENERATES  
MONEY FOR YOU!**

**It's a DOG FIGHTER, TOO!**

The Model ATC-10 is much more than a color bar pattern generator. It should be called a **portable multi-purpose TV diagnostic and servicing aid**, but that's too much of a mouthful. We would have nicknamed it the **Dog Fighter** (instead of the Money Generator), but that might be misinterpreted to mean that it's only useful in the shop. The versatile ATC-10, a portable, moderately-priced instrument, combines the most essential features of a color bar pattern generator, a TV "analyzer," and a substitute tuner plus several brand new "dog fighting" and timesaving innovations. With all this extra versatility, however, the ATC-10 is human engineered with only four simple-to-master controls.

Two illustrated brochures describe the ATC-10. The first brochure describes the many unique and unusual features which make the ATC-10 a "dog fighter" and a time-saver. The second brochure compares the money-making potential of the ATC-10 with 18 competitive models. It includes a comprehensive chart which compares the features of 19 makes and models, lists the estimated timesaving potential of these 33 respective performance features, and then calculates the money making potential of the various models. We think you are in for some surprises, such as the potential of the ATC-10 for returning its \$299.95 purchase price in as little as three or four months.

These brochures are yours for the asking — write direct for immediate reply.

**American Technology Corporation**  
 225 Main, Dept. 3A, Canon City, CO 81212

For More Details Circle (18) on Reply Card

(Continued from page 48)

continue re-dialing until the radio signal is sent. Human handling of telephone calls for paging is not necessary because the "Auto Page" can link the answering machine directly to paging computers.

For More Details Circle (55) on Reply Card

### Outdoor Speaker

The Kriket KC-45 outdoor speaker is the newest voice communications product available from Acoustic Fiber Sound Systems.

It features the patented Working Wall enclosure, a patented, cross-laminated, tubular fiberboard construction. Sound is controlled and distortion is reduced.



Built for external mounting on boats, sports vehicles, or tractors, the KC-45 is said to be the first acoustically-designed weatherproof speaker. It is crafted with an impact-resistant, Duralex cover.

For More Details Circle (56) on Reply Card

### Stereo Headphones

Three new stereo headphones are offered by the Calectro Division of GC Electronics.

They connect to amplifier outputs of 4 to 16 ohms, and feature adjustable headbands, removable foam-cushion earpieces and a 10-foot coiled cord with stereo plug.

For More Details Circle (57) on Reply Card

### Powerful Auto Speakers

A new auto speaker series, the "Pyle Drivers", has been announced by Pyle Industries.

The most powerful model of the series is a 6" x 9" with a 6½-pound magnet structure and 1½" voice coil. Pyle claims this to be the heaviest magnet structure and the largest voice coil ever offered to the automotive speaker market. It will handle 100 watts of peak power.

All models feature heat-proofed voice coils, compliant foam edge rolls and heat-set epoxy bonds between the voice coil form and the cone. One



model has a 3" co-axially-mounted tweeter. The entire series consists of 4 speakers and 6 kits.

For More Details Circle (58) on Reply Card

### Telephone Recorder

"Multi-Tele Recorder" is a fully automatic, self-contained recorder available from Goodrich Products. It connects easily to any telephone, and



only starts when your phone is used. It will record up to five lines as selected, and does not interfere with telephone operation.

Suggested retail price of the Multi-Tele Recorder is \$99.95.

For More Details Circle (59) on Reply Card

### Phone-Answering System

Ford Industries announces its "Code-A-Phone" Model 222, an automatic answering-and-recording system designed for home and office use.

The Model 222's 20-minute incoming-message tape is voice controlled, and shuts off automatically at



the end of the caller's message. It's designed for announcements up to 28 seconds in length.

The new unit is small and compact and has a built-in speaker and microphone.

For More Details Circle (60) on Reply Card

## antenna systems report

*These features supplied by the manufacturers are listed at no-charge to them as a service to our readers. If you want factory bulletins, circle the corresponding number on the Reply Card and mail it to us.*

### TV Signal Indicator

"Levelite", developed by Jerrold Electronics, quickly indicates whether the total TV signal level from a MATV system or home antenna is sufficient for good reception or not. This small, hand-held test unit has two Light-Emitting-Diode (LED) indicators. One LED lights in red to show adequate power from the 9-volt battery. Brightness of the red LED is determined by the amount of signal, and the setting of the "DISTANT-LOCAL" sensitivity switch. In the distant position, the green LED barely glows at -6 dBmV, and shines with full brightness with -2 dBmV of signal. Local sensitivity is +6 dBmV when the LED is dim, and +10 dBmV when it's bright. Thus, the Levelite gives an approximate reading of total signal level. Bandwidth has been restricted to Channels 7 through 13 to prevent false readings from strong FM signals.

Input signals are amplified and detected to provide a DC voltage, which drives the green LED. Adapters are included for connecting "F", "G", autoplug, and 300-ohm fittings at any point of an antenna system.

The Levelite L-200 tester comes in a padded carrying case that has a belt clip, and sells to dealers for \$47.50, less battery.

For More Details Circle (61) on Reply Card

### Auto FM Booster

"Stereo One" by the Finney Company amplifies the FM signal without affecting AM performance, to minimize flutter and signal fading during FM-stereo reception in autos.

The on/off control unit mounts on the dash; the amplifier section is connected in series with the original antenna cable, and it mounts near the auto radio.

FM signal strength is tripled, according to the manufacturer, and "Stereo One" should not overload even with strong local signals. Installation is said to take only a few minutes, with instructions and mounting hardware furnished.

For More Details Circle (62) on Reply Card



### 4-Way Amplifier/Splitter

Ava Electronics offers Model A515-4UV, which is a VHF/FM/UHF amplifier with a built-in 4-way splitter. Bandwidth is said to be between 50 MHz and 900 MHz, with 75-ohms input impedance and 75-ohms to each of the splitter outputs. Powered from

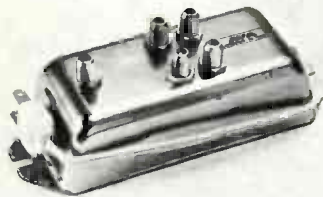

120 volts AC through an isolation transformer, Model A515-4UV can be used with as many as 16 TV receivers in a MATV system.

The amplifier lists for \$49.95.

For More Details Circle (63) on Reply Card

### All-Weather Couplers

A new line of passive all-weather TV/FM signal-reception and distribution devices is offered by Jerrold Electronics.

Model 3001 is a transformer-type 2-set coupler; Model 3007 separates FM and TV signals; Model 3008 combines the outputs of yagi and broad-band antennas to a single download; Model 3014 divides VHF and UHF signals at 300-ohms; Model 3014-75 is the same as Model 3014, except for 75-ohm operation; Model 3016 combines the signals from hi-band VHF and low-band VHF antennas to a single download; and Models 300TT20-2 through 300TT20-13 are traps giving 20-dB attenuation of a single VHF channel while passing the others.

For More Details Circle (64) on Reply Card

### High-Pass Filter/Transformer

Functions of a high-pass filter and a 75-to-300-ohm matching transformer are combined by RMS Electronics in the Model 2600F. The filter action minimizes interference from CB or amateur-radio transmissions, as well as other carriers and noises.

This transformer, which has an "F" connector at the 75-ohm input and twin-lead with lugs at the 300-ohm output, replaces a conventional balun transformer. Attenuation between 5 MHz and 35 MHz is said to be 28 dB.

A wide variety of output connectors are available for use in MATV systems.

For More Details Circle (65) on Reply Card

### Long-Range CB Antenna

A mobile CB antenna 102" high is said to increase the range by giving a better signal-to-noise ratio, and mini-

mizing the effects of terrain problems. "Overlord" antenna by Pearce-Simpson is constructed of white fiberglass for strength and visibility, and machined-brass fittings.

For More Details Circle (66) on Reply Card

### TV Bandpass Filter



Model BPF-A single-channel bandpass filters provide a high rejection of signals outside the channel. They are available from Blonder-Tongue for all low-band, mid-band, and high-band VHF TV channels. The number following BPF-A indicates the correct channel.

Bandpass is 5.3 MHz  $\pm$  3/4 dB for channels 2 through 6, and the ampli-

tude of trapped carriers is 60 dB. Impedance is 75-ohms input and output, and the cable connectors are "F" type.

These bandpass filters are intended for MATV and CATV systems to minimize interference from adjacent channels, and should be added before single-channel amplifiers.

For More Details Circle (67) on Reply Card

### Base-Station CB Antenna

A quarter-wave vertical radiating element and three quarter-wave radials to produce an elevated ground plane (artificial ground) are features of the Model 11-101 omni-directional permanent 27-MHz antenna offered by Breaker.

The assembly includes built-in lightning protection, 50-ohms impedance with a SO-239 connector, high-impact molded base, shunt-loaded beta-match element, and mounting hardware.

For More Details Circle (68) on Reply Card

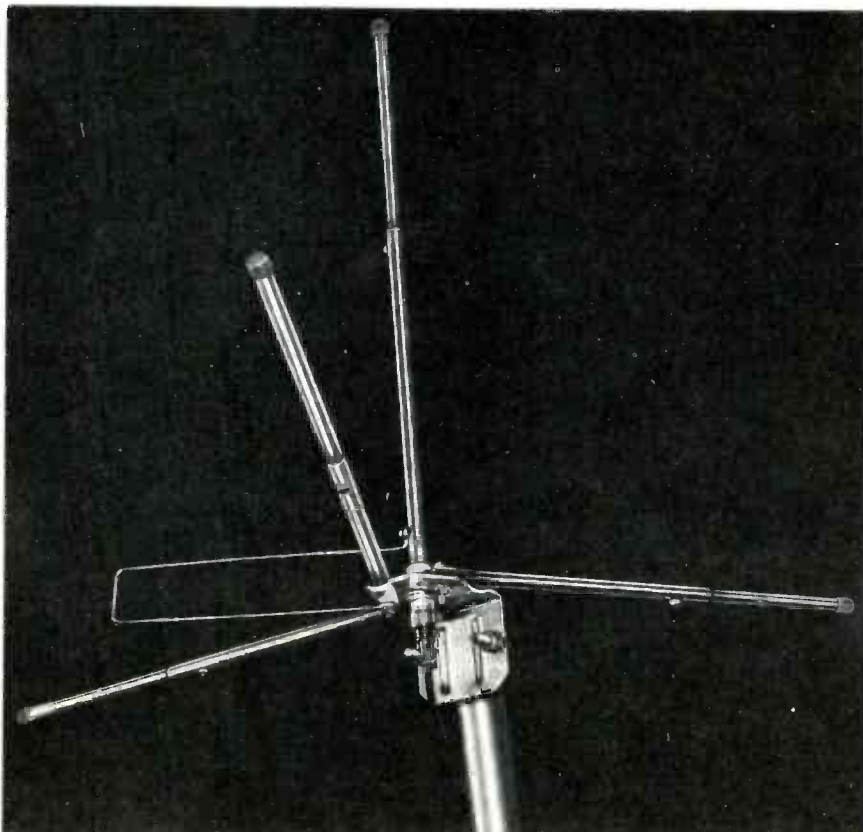

# catalogs literature

Circle appropriate number on Reader Service Card.

**100. Jensen Tools and Alloys**—offers a free 112-page tool catalog describing over 2,500 individual items. Sections include hand tools, power tools, metalworking tools, soldering equipment, optical equipment, test equipment, and electronic chemicals. Also featured is a solder section.

**101. Channel Master**—has available a UHF antenna catalog. Nine UHF antenna types designed for color TV are described and illustrated. Sixteen models are shown, plus various special designs and combinations. The brochure covers antennas for every type of reception area, in all price ranges, and includes performance data.

**102. Hewlett-Packard**—a 32-page brochure—the "Pocket Calculator Buyer's Guide"—describes and gives specifications for the company's full line of preprogrammed and programmable pocket calculators. The free brochure, #5952-6062D, also includes a complete listing of HP pocket-calculator accessories, support literature and prerecorded programs.

**103. Audiovox**—offers a free speaker application chart. The three-color specially-coded chart unfolds into a 17" X 21" poster for easy interpretation. The chart is designed to show the recommended speakers and available locations for import and domestic cars back to 1970. It lists the speaker type, dimensions, kit number and magnet weight of the mini, in-door, in-deck, surface, convertible and coaxial speaker models.

**104. Nortronic Company**—has available the 7th edition of its "Nortronic Recorder Care Manual." It shows step-by-step, illustrated methods for maintenance of recording machines and the proper method for splicing tape. A new feature of the current edition is a revised catalog section of consumer

recorder-care products. Also included is a bibliography of helpful books for those who wish to learn more about tape recording.

**105. Tektronix**—the 48-page catalog number A-3183 contains up-to-date data on new TM500 products, such as the SC502 dual-channel oscilloscope and TM515 Traveler Mainframe. It also contains full specifications on the more than 30 TM500 plug-in modular instruments, and features thirteen articles discussing instrumentation technology.

**106. Hickok**—has a free 16-page catalog describing its full line of portable and bench test instruments. Products covered include single- and dual-trace oscilloscopes, a digital multimeter, a function generator, a curve tracer, FET multimeters, semiconductor testers, color-bar generators, tube testers, a CRT tester/rejuvenator, and a sweep-and-marker alignment generator. Features, operating data, and complete specifications are given for each unit.

**107. Cleveland Institute of Electronics**—offers a 40-page, four-color catalog covering independent home-study courses, and containing a 24-page section which details each of CIE's 13 electronics-training programs. Each course is outlined with course objective and listing of subjects covered. Other departments include: information about career opportunities in electronics; facts on CIE's background and school/student relationship; and an outline of the school's employment assistance program.

**108. Shure Brothers**—expanded and updated catalog of Shure professional products for broadcasting, recording, and motion pictures lists Shure microphones, audio components and accessories, and high-fidelity phonograph cartridges. Included in the free catalog are specifications and individual performance profiles, as well as data about installation.

**109. Saxton Products**—the 52-page catalog features coaxial and twin-lead cables for CB, amateur radio, and television use, plus antenna-

mounting hardware, tools, hook-up wire, intercoms, audio connectors, and decorator telephones.

**110. Mountain West Alarm Supply**—has a free 96-page A-76 "Alarm Equipment Catalog", which describes more than 500 intrusion and fire-alarm products, many UL listed. An informative alarm equipment application guide (which includes general alarm-system discussion, basic installation procedures, and connection diagrams) is a featured section. This selection of alarm equipment is complete from simple kits to the latest ultrasonic, radar, and infrared detectors. □

## ONE-SEVENTH OF YOUR EMPLOYEES MAY BE DYING. HELP SAVE THEIR LIVES.

High Blood Pressure is the country's leading contributor to stroke, heart disease and kidney failure. Any of which can kill.

And, one out of every seven of your workers has it. Half have no idea they're walking around with this time bomb inside them.

But you can help. By giving your employees a chance to check their blood pressure. Your own medical or nursing personnel can do the job, simply.

To help you implement this life-saving program, we have a special kit, "Guidelines for High Blood Pressure Control Programs in Business and Industry."

Write to: National High Blood Pressure Education Program, 120/80, National Institutes of Health, Room 1012—Landow Bldg., Bethesda, Md. 20014.



**HIGH BLOOD PRESSURE.**  
Treat it...and live.

## Solution to: OHMWARD BOUND!

- |               |                |
|---------------|----------------|
| 1 ZinC        | 18 FeedeR      |
| 2 CemenT      | 19 RectangulaR |
| 3 ThermioN    | 20 RipplE      |
| 4 NorM        | 21 EpoxY       |
| 5 MetriC      | 22 Yagl        |
| 6 ChaD        | 23 IroN        |
| 7 DaraF       | 24 NeutraL     |
| 8 FemaLE      | 25 Layout      |
| 9 Exhaust     | 26 TraceR      |
| 10 TwisT      | 27 RemotE      |
| 11 TensioN    | 28 ElectreT    |
| 12 NewtoN     | 29 TangenT     |
| 13 NuIL       | 30 ToroiD      |
| 14 LoudnesS   | 31 DiopteR     |
| 15 SeptuM     | 32 RubbeR      |
| 16 MosaiC     | 33 Rating      |
| 17 CloverleaF |                |

Start with 132 points and deduct 4 points for any part you may not have answered correctly.

Your rating:

- 68 - 80 Well-I-I-I-I.  
 84 - 96 Pretty good.  
 100 - 112 Very good.  
 116 - 128 Excellent.  
 132 PERFECT! Stop in and we may let you treat us to coffee and...

### Audio Test Answers

(Continued from page 24)

- |         |         |         |
|---------|---------|---------|
| 1. (B)  | 11. (A) | 21. (A) |
| 2. (B)  | 12. (A) | 22. (B) |
| 3. (B)  | 13. (B) | 23. (A) |
| 4. (B)  | 14. (B) | 24. (A) |
| 5. (A)  | 15. (B) | 25. (A) |
| 6. (B)  | 16. (A) | 26. (A) |
| 7. (A)  | 17. (B) | 27. (A) |
| 8. (B)  | 18. (A) | 28. (B) |
| 9. (A)  | 19. (B) | 29. (A) |
| 10. (B) | 20. (B) | 30. (B) |

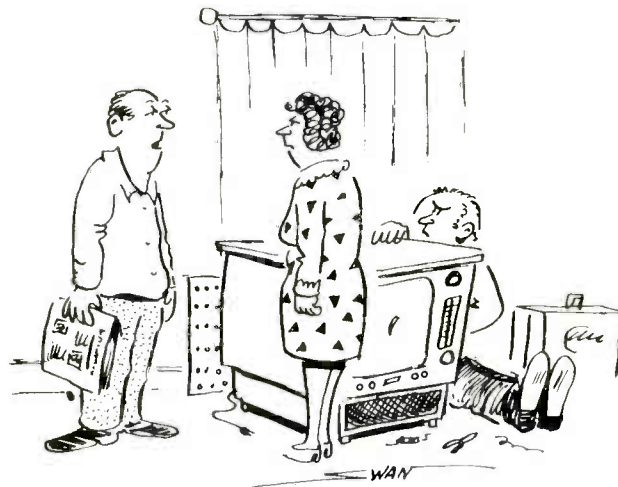

"Why not be a good sport and let him fix what he thinks is wrong with it?"



"...And it will allow your wife to ruin a roast in one-fourth the time it used to take her."

### FREE ALARM CATALOG

Huge selection of burglar & fire systems, supplies. Motion detectors, infrared beams, controls, door switches, bells, sirens. 500 items, 99 pp. packed with technical details, notes.



(Outside U.S., send \$1.00.)  
**mountain west alarm**  
 4215 n. 16th st., phoenix, az. 85016

For More Details Circle (20) on Reply Card

### APPLIANCE REPAIR BOOKS

Written in easy-to-understand language by experts with illustrations & diagrams. Acclaimed by instructors & professionals. How to diagnose & repair air conditioners, refrigerators, vacuum cleaners, ranges, washers, dryers, steam irons, portable kitchen appliances, water heaters; plus how to set up a shop, using test instruments and more. Only \$2.65 to \$4.90 each!

**SEND FOR FREE DESCRIPTIVE PRICE LIST**  
 C & N, DEPT. ES, 5841 MONTROSE, CHICAGO 60634

For More Details Circle (21) on Reply Card

March, 1976

# ACA

ANTENNAS  
 FIELD-ENGINEERED and TESTED  
 in your area  
 FOR YOUR AREA

CALL or WRITE:

ACA, P. O. Box 865, Burlington, IA 52601 Phone: 319/753-1625

For More Details Circle (19) on Reply Card



# The MARKETPLACE

This classified section is available to electronic technicians and owners or managers of service shops who have for sale surplus supplies and equipment or who are seeking employment or recruiting employees.

Advertising rates in the Classified Section are 35 cents per word, each insertion, and must be accompanied by cash to insure publication.

Each initial or abbreviation counts a full word.

Minimum classified charge \$3.00.

For ads on which replies are sent to us for forwarding (blind ads), there is an additional charge of \$3.00 per insertion to cover department number, processing of replies, and mailing costs.

Classified columns are not open to advertising of any products regularly produced by manufacturers unless used and no longer owned by the manufacturer or a distributor.

## FOR SALE

**ADVERTISING PACKAGE FOR TV service shops.** Inexpensive eye catching ads contain personal message from you-build customer confidence. Keeps your name before the public weekly. **PROVEN RESULTS.** Thirty ads with instructions \$19.95 Sample \$1.00 refundable. TV TIPS, 430 South Jefferson, Lebanon, Mo. 65536. 11-75-81

**NEW Canadian Magazine "Electronics Workshop".** \$5.00 yearly. Sample \$1.00. Ethko, Box 741, Montreal "A" Canada. 10-75-121

**CONVERT** any transistorized T.V. tuner to a tuner substituter. Plans \$2.00 New accelerated Radio & T.V. course. **RADIO TELEVISION TRAINING.** Box 279, ES-36, Syracuse, N.Y. 13206. 8-75-tf

**TEKTRONIX SCOPES**—Hewlett-Packard generators, other test and electronic equipment parts, tubes, "ham" supplies, surplus, and older parts. **ELECTRONIC SPECIALTIES,** 1659 W. Wetmore, Tucson, Az. 85705. (602) 887-9729. 1-76-121

**TELEPHONE MONITOR!** Record business, personal conversations automatically. Limit unauthorized calls! Also, **PORCELAINS! TOYS! GIFTS! JEWELRY** 30% OFF, postpaid! 171-page catalog. \$2. ES2, Box 192, Griffith, IN 46319. 2-76-2t

**REJUVENATE TV** Picture Tubes without expensive equipment. Use clip leads in power from set and tube manual. Plans \$5.00. W. R. Collins Jr., 4 TC BDE PPO APO, NY, NY 09451. 2-76-2t

**COLOR TELEPHONES**—New American made with one year warranty. Free information or send \$1. for color digest and prices. Telectra Sales, Box 9218-ES, Richmond, VA. 23227. 2-76-3t

**OLDER & OBSOLETE** Radio and TV tubes all new and boxed. We have several thousand. Send for list & prices. Garrett, P.O. Box 2055, San Diego, California 92112. 2-76-2t

**FOR SALE:** B&K Alignment generator. Model 415, perfect—\$300.00. Telesonic TV, 173 Lexington Ave., Mt. Kisco, N.Y. 10549. (914) 666-3902. 3-76-1t

## FOR SALE (CONT.)

**STOP...**don't junk that television set. ASE manufacturers the world's most complete line of television picture tubes. No other company offers: Over 1700 types of television picture tubes. Most types immediate delivery. Transportation in the Midwest—paid, 1/2 transportation paid in other states. Tubes for Old or New Models. Complete line of both black & white and color. Full 2 year factory warranty. Lowest prices anywhere. Finest quality. Write today for more information. Allied Sales & Engineering, Inc., Dept. 27, Pimento, Ind. 47866, Telephone - 812-495-6555. 2-76-2t

**FOR SALE:** Philco Model 89, code 121 radio, one tube missing. R. Auman, Box 3, Millheim, Penn. 16854. Free for Parts: One "Corsair 11 Transmitter/rec." Pay Shipping Costs. Hudson American Corp., New York. 3-76-1t

**SAMS**—1176 through 1479 plus over 50 others, \$695. B&K 415 sweep marker generator, \$295. B&K 1460 triggered oscilloscope with new CRT—needs repair, \$175. Entire package, \$1100. Jim Anderson, RR2, Box 93E, Beckley, W. Va. 25801. 255-1501. 3-76-1t

**TELEPHONE MONITOR:** Record business, personal conversations automatically. Limit unauthorized calls! Also, **PORCELAINS! TOYS! GIFTS! JEWELRY!** 30% OFF, postpaid! 171-page catalog. \$2. ES3, Box 192, Griffith, IN 46319. 2-76-2t

## EDUCATION-INSTRUCTION

**REPAIR TV TUNERS**—High Earnings. Complete Course Details. 12 Repair Tricks. Many Plans. Two Lessons, all for \$2. Refundable. Frank Bocek, Box 3236 Enterprise, Redding, Calif. 96001. 10-75-6t

**TV PROBLEMS???** Send symptoms with a copy of schematic and self-addressed stamped envelope and \$2.00, to Troubleshooter, Box 4553, Downey, Ca. 90241. Results Guaranteed. 9-75-tf

## BUSINESS OPPORTUNITY

**DEALER INQUIRIES** invited. Add color telephones and accessories to your sales. Send for additional information on business letterhead. Telectra Sales, Box 9218-ES, Richmond, VA. 23227. 2-76-3t

**TV SHOPS**—Needed to repair and update master antenna systems with new patented method. I will train you. No competition. You will be one of a select number directly under my technical assistance by WATS telephone. Send resume and credit references: Melvin Cohen, Television Broadcast Engineer, May Company Building, 3651 Prospect Avenue, Riviera Beach, Fla. 33404. Enclose 13 cents addressed envelope. Be patient for my reply. 11-75-6t

**INCREASE SERVICE PROFITS**—Avoid consumer problems. Business Manual tells how. Contract Manual shows how to get paid before you service and hold customers. Either book \$15.00, both \$25.00. NATESA, 5908 S. Troy, Chicago 60629. 2-76-3t

**TV SHOPS:** Qualify for my telephone assistance to solve your "Tough Dog" TV repairs that waste bench space. Send resume and credit references: Melvin Cohen, Television Broadcast Engineer, May Company Building, 3651 Prospect Avenue, Riviera Beach, Fla. 33404. Enclose 13 cent addressed envelope. Be patient for my reply. 3-76-2t

**CALIFORNIA BOUND?** Take over established TV/Hifi shop on easy terms. Nets \$20,000+. Box 157, Palo Alto, 94301. (415) 327-5320. 3-76-3t

## WANTED

**NEEDED:** Flyback for R.C.A. Chassis CTC9, part #106359. R. L. Cantrell, 205 N. Donley St., Tullia, Texas. 79088. 3-76-1t

**WANTED:** Factory Sales Rep. for state of Ohio. Rebuilt TV picture tubes and special purpose C.R.T. Contact Newton Electronics, Inc., 401 Ash St., Willard, Ohio. (419) 935-5175. 3-76-1t

# advertisers' index

American Technology Corporation .....	49
Antenna Corporation of America .....	53
B & K Div., Dynascan Corporation .....	1
Bussmann Mfg. Div., McGraw-Edison .....	3
Castle Electronics, Inc. Cover 4	
Charous & Niebergall .....	53
Chemtronics Incorporated ..	13
Dana Laboratories, Inc. ....	13
Fordham Radio .....	47
Gem City Tuner .....	10
General Electric Company ...	12
Heath Company .....	16
Hickok Electrical Instrument Co. ....	45
Lectrotech, Inc. ....	14
Mallory Distributor Products.	17
Motorola Training Institute ..	43
Mountain West Alarm Supply Co. ....	53
Precision Tuner Service .....	Cover 2
Projector-Recorder Belt Co. .	47
RCA Distributor and Special Products .....	11
Howard W. Sams & Company, Inc. ....	7
Sperry Tech, Inc. ....	16
GTE Sylvania - Consumer renewal .....	9
Tab Books .....	44
Tuner Service Corporation ....	5
Winegard Company ....	Cover 3

# Give till it helps.

**+** The American Red Cross. The Good Neighbor.

A Public Service of The Magazine & The Advertising Council (AMC)

John Buckner, independent installer says:  
**“Winegard Chromstar  
 has proved it does  
 a beautiful job.”**

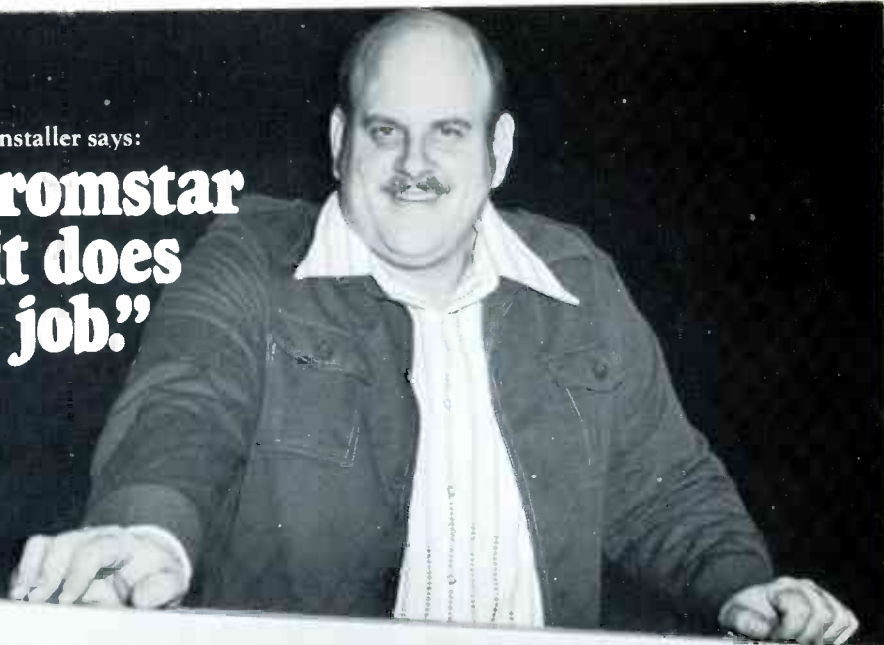

**WINEGARD**  
**Chromstar** tv antenna

“... quality of Winegard products,  
 ... far surpasses other brands ...”

“We depend on the Winegard Chromstar  
 Antenna for quality color reception.”

“... tremendously pleased with the  
 reception the Winegard Chromstar  
 antenna gets in our area.”

Get all the facts from your Winegard Distributor.  
 Free Spec Charts on all models.

These statements are from John A. Buckner, President of Buckner Co., Lyndon, Kentucky, who adds in his letter,\* “We have a unique situation in the Louisville area, with all television signals coming from a ridge west of town, and their power output varying greatly. We have two VHF stations — Ch. 3 and 11 — and four UHF stations — Ch. 15, 32, 41, and 68. We must cover a broad range of signals, and an even wider variation of power output levels from these stations. The Winegard Chromstar antenna has proved to us and our customers that it does a beautiful job.”

\*A copy of Mr. Buckner's letter will be sent to you on request.

LOOK TO CHROMSTAR FOR QUALITY AND PERFORMANCE

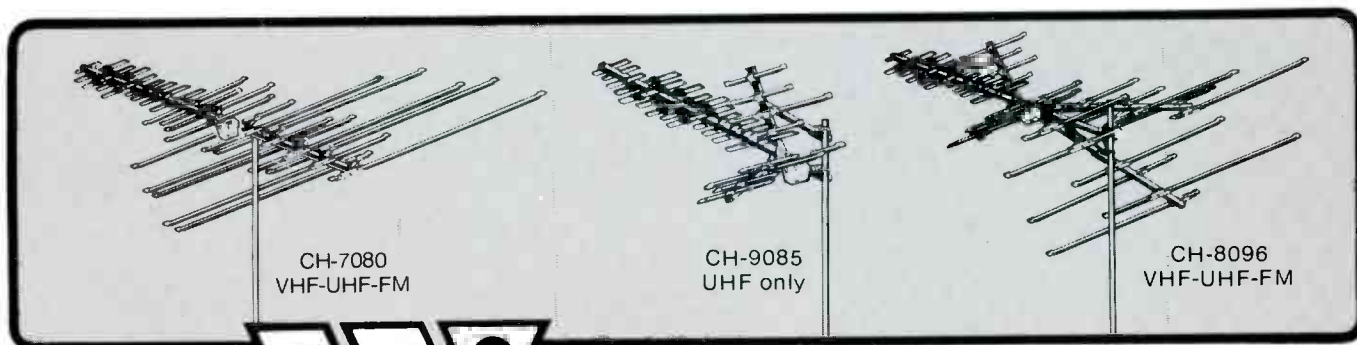

**WINEGARD**<sup>®</sup>  
 C O M P A N Y  
 3000 Kirkwood • Burlington, Iowa 52601

**TV ANTENNAS MORE PEOPLE LOOK UP TO.**

For More Details Circle (2) on Reply Card

# The Tuner People

...offer something

# NEW

*Custom Service*

*... for the  
Professional*

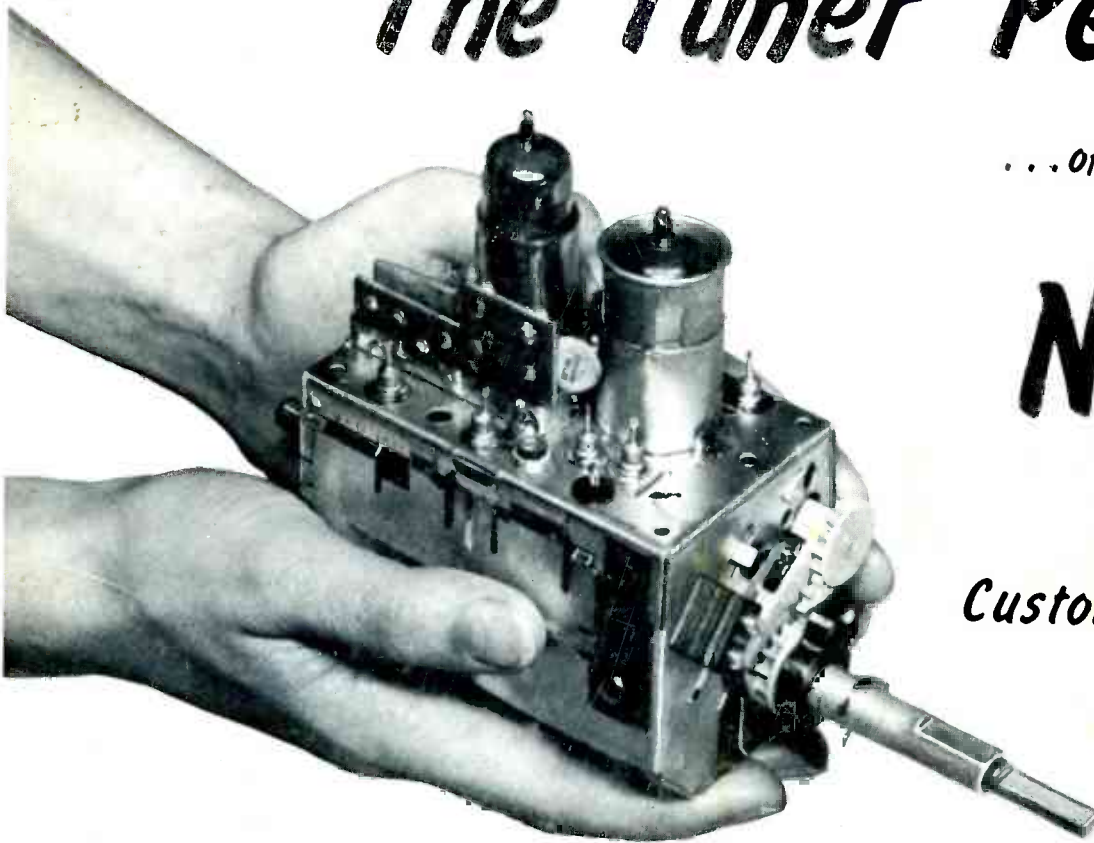

Yes! Castle, the pioneer of TV Tuner overhauling, gives you 25 years of expertise and professional experience behind every tuner processed under our new Custom Service.

Each order is handled on an individual basis with documentation of performance and service recorded for each tuner. This Custom Service guarantees you expert analysis of the tuner; precise, skilled alignment . . . and no harmful, unusual cleaning processes. Your need to return for further service in warranty is reduced to an absolute minimum . . . when you receive the tuner under Castle's Custom Service you know that it is right!

*What does this Custom Service cost?*

#### Castle Custom Overhaul Service.

Individual overhauling of any TV Tuner, tubes and transistors extra.

\$12.95

Send defective tuner only to Castle, remove ALL accessories.

#### Castle Custom Stock Replacement Tuners.

Engineered by Castle to provide exact replacement . . . giving original, or improved performance. Purchase outright — no exchange required — send for list of tuners available.

\$17.95

#### Castle Custom Exchange Replacement Service and Custom Rebuilding.

This is a custom service offered when the original tuner is unfit for overhaul and a Castle Custom Stock Replacement is not available. Each tuner is exchanged for an exact replacement tailored to custom order; or the original tuner is professionally rebuilt to perform to original specifications. All inclusive price.

VHF \$21.95  
UHF \$17.95

REMEMBER . . . Castle Custom Service is as near as your Post Office. All prices are f.o.b. our plant. We will ship C.O.D.



## CASTLE TV TUNER SERVICE

5701 N. Western Ave., Chicago, Ill. 60645 • Ph. (312) 728-1800

For More Details Circle (3) on Reply Card